

50°

mobirolo

1966

2016

2017



general  
catalogue

 **mobirolo**



6

**scale con il vetro**

Glass staircases

28

**scale a giorno modulari**

Modular open staircases

50

**scale a giorno in legno**

Open staircases

98

**scale per piccoli spazi**

Staircases for small spaces

104

**scale a chiocciola**

Spiral staircases

128

**scale per esterno**

Outdoor staircases

132

**ringhiere**

Banister for masonry staircases

138

**scale rientranti**

Retractable staircases

140

**colori**

Colors



---

# FIFTY YEARS OF VERTICAL DESIGN

---

Fu Leonardo da Vinci il primo studioso a teorizzare la possibilità di risalire all'età di un albero semplicemente contandone gli anelli disegnati all'interno del tronco. Ogni anello un ciclo di quattro stagioni. Gli anelli più spessi segnano gli anni piovosi, i più sottili quelli di siccità. Nel 2016, la quercia Moberolo ha aggiunto il cinquantesimo anello. Un ringraziamento a tutti coloro che hanno contribuito a farci crescere con solide radici.

50°  
moberolo  
1966  
2016

Leonardo da Vinci was the first scholar to trace back the age of a tree by simply counting the rings layered in a circle inside the trunk. Every ring is a four-season cycle. The thicker rings mark rainy years, the thin rings the dry ones. In 2016, Moberolo put on its fiftieth ring. Our gratitude goes to all those who helped us grow with upon solid roots.

---

# MOBIROLO GREEN PHYLOSOPHY

---



Non c'è bellezza senza rispetto. Ci impegnamo a rispettare i cicli naturali e gli equilibri dell'ambiente, e lo facciamo concretamente: riciclando gli scarti di lavorazione del legno per il riscaldamento dei reparti produttivi e per il riutilizzo da parte di aziende specializzate; credendo da subito alla certificazione FSC®, che garantisce che il legno di faggio che utilizziamo provenga da foreste gestite e controllate «responsabilmente», nel rispetto etico di persone e risorse; proteggendo i nostri prodotti in legno con verniciatura “all'acqua” che riduce notevolmente l'emissione in atmosfera di agenti chimici nocivi.

There is no beauty without respect. We are committed to respecting mother earth's natural cycles and balance, and we do so with a material approach: we recycle our wooden production waste to heat the production areas or transfer to specialised operators for reuse; we immediately believe in the FSC® certification, which guarantees our beech to be sources from forests managed and controlled «responsibly», ethically respecting people and resources; protecting our wooden products with “water-based” paint that remarkably reduces noxious chemical emissions.



---

# MADE IN ITALY

---



Siamo cresciuti con la promessa di dedicare gli sforzi del nostro lavoro alla ricerca del bello e del ben fatto. Poche cose ci danno soddisfazione come il riuscire a valorizzare un ambiente con una scala. Perché dopo 50 anni ti accorgi che la cosa più importante è non smettere mai di impegnarsi a portare la bellezza negli spazi abitati dalle persone. Crediamo sia un valore far sapere, a chi salirà i gradini fabbricati nei nostri stabilimenti, che le scale Mobirolo sono disegnate e realizzate nel paese in cui la Bellezza è da sempre un valore: l'Italia.

We grew with the promise of devoting our best effort to researching the beautiful and well crafted. Few things make us happier than bringing out the beauty of a space with a staircase. Because after 50 years you realise that what matters is never to stop doing your best to bring beauty in people's homes. It is a value, we believe, to let those whose feet will step on our staircase know that Mobirolo staircases are designed and manufactured in the Country where beauty has always been a value: Italy.

 **mobirolo**

## scale con il vetro

Glass staircases

### Perchè scegliere una Scala con il vetro Mobirolo?

Why choose a Mobirolo glass staircase?

glass

#### **Disegnate su di te.**

Ogni nostro modello viene dimensionato in base alle misure del tuo spazio. Si adatta al tuo ambiente lasciandoti ampia libertà di scelta tra finiture e materiali di qualità.

#### **Una solida sicurezza.**

Solidità della struttura garantita da una portata di 400 kg/m<sup>2</sup>. Con la garanzia di un vetro ad alta prestazione.

#### **A misura di bambino.**

Il pannello in vetro delle ringhiere forma una barriera Invalicabile anche per i più piccini, come previsto dalla normativa per la sicurezza dei bambini.

#### **Adattabili al tuo spazio.**

Le nostre scale si adattano ottimamente allo spazio grazie a pedata ed alzata a misura per te, per la massima comodità possibile.

#### **Designed around you.**

Every model we make is sized to the measures of your space. It adapts to your environment and leaves you with extensive choice among finishes and quality materials.

#### **Solid and dependable.**

The solid structure is guaranteed by the 400-kg/m<sup>2</sup> capacity. With the guarantee of high-performance glass.

#### **Made to measure for children.**

The glass panel on the banister forms an insurmountable screen for younger children as prescribed in the regulation for children's safety.

#### **Adapts to your space.**

Our staircases adapt perfectly to space thanks to made to measure tread and riser, for the highest possible comfort.

#### **Un design trasparente.**

Questa serie di scale si caratterizza per un uso intenso del vetro, per dare trasparenza e leggerezza alla tua casa.

#### **Scegli il tuo stile.**

Ampia possibilità di scelta di materiale e design per ringhiera e balaustra.

#### **Coordiniamo il gusto.**

La balaustra è realizzata con gli stessi elementi che compongono la ringhiera della scala.

#### **L'innovazione della luce.**

Scopri i modelli in cui è disponibile il sistema di illuminazione a LED automatizzato.

#### **Cura dell'ambiente.**

Attenzione a salute e ambiente grazie alla verniciatura "ad acqua" del legno.

#### **Transparent design**

This staircase series stands out for an intensive use of glass, providing transparency and lightness to your home.

#### **Choose your style.**

A wide selection of materials and designs for the handrail and banister.

#### **Combining taste with consistency.**

The banister is made of the same elements as the one along the steps.

#### **Lighting innovation.**

Find out about the models featuring the automated LED lighting system.

#### **Care for the environment.**

Care for health and the environment thanks to our "water-based" painted wood.



## REXAL XC

*scale con il vetro*  
*glass staircases*

glass  
series

■ Rexas, la novità della collezione Mobirolo, ideata per gli spazi del futuro, con forme e materiali concepiti per durare nel tempo mantenendo originalità e carattere.

La trasparenza del vetro e la solidità dell'acciaio fanno di Rexas una scala con caratteristiche esclusive di design e solidità della struttura.

Una qualità unica che contraddistingue l'eccellenza ed il prestigio delle scale Mobirolo.

■ Rexas, the new stair proposal of the Mobirolo collection, imagined for living spaces of the future, is made by materials conceived to get on for long as far as its originality and character. Rexas, a stair with a stylish design and a solid structure thanks to the transparency of glass and the strength of steel. A unique quality as the prestigious emblem of excellence, that marks the Mobirolo collections.

9

Struttura verniciata bianco raggrinzato 90RG, gradini in faggio lamellare tinta tortora 430, ringhiera a pannelli di vetro curvo, stratificato e temprato mm 10+10 di colore extrachiaro C0006.

Painted structure in 90RG wrinkled white color, finger joint beech treads in 430 dove grey color. Banister with bent, stratified and tempered glass panels mm 10+10, extra light color C0006.

|← mm →| 700 ÷ 1000

## SCEGLI E PERSONALIZZA LA TUA SCALA

Select your staircase and personalize it

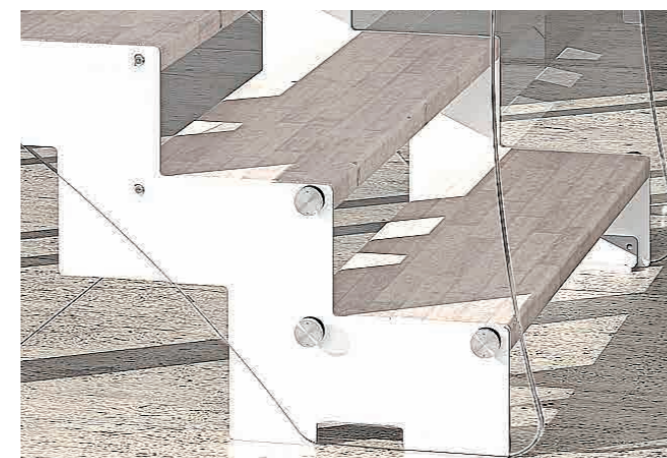

Personalizza la tua scala, fai di Rexal una scala che sia solo tua, realizzata su misura. Potrai scegliere i materiali più adatti al tuo ambiente, la struttura in acciaio inox satinato o verniciato in quattro diverse varianti colore, da abbinare ai gradini in vetro stratificato o in legno di faggio o rovere con ringhiera nelle varianti in acciaio inox, cromata e vetro.

Pick your stair. Turn Rexal in your personal stair, customized especially for you. You can choose the materials more suitable for your living spaces: the glazed or painted steel structure in four different colours, to combine with steps of stratified glass or beech wood or oak wood with inox or chrome or glass banister.

### ◀ REXAL CHROME RG

Struttura verniciata bianco raggrinzato 90RG, gradini e corrimano in faggio lamellare tinta bianco spazzolato 305S, ringhiera a colonne bianche con pannelli in vetro stratificato mm 6+6 extra chiaro C0006.

Painted structure in 90RG wrinkled white color, finger joint beech treads and handrail in brushed white 305S color. Banister with white columns and stratified glass panels mm 6+6 in extra light color C0006.

|← mm →| 700 ÷ 1000

■ Portata scala: kg 400/m<sup>2</sup>  
Altezza massima della scala mm 3500

■ Load capacity: kg. 400/ m<sup>2</sup>  
Staircase height up to mm 3500





**ESPERIA VITRA**  
*scale con il vetro*  
*glass staircases*

glass  
series

Scala in legno di Faggio lamellare tinta Tortora 431 dec ■  
(disponibile anche in Rovere) ringhiera a pannelli di vetro  
stratificato mm 5+5 o 6+6 di colore extra chiaro C0006.  
Disponibile con sistema di illuminazione Led (optional).

Stair of finger joint beech wood 431 dec dove grey color ■  
(available also in oak wood).  
Banister with stratified glass panels mm 5+5 or 6+6,  
extra light color C0006.  
Option Led system available.

|← mm →| 650 ÷ 1000



**FLY XC**  
*scale con il vetro*  
*glass staircases*

Scala in legno di rovere lamellare tinta cacao 410 ■  
(disponibile anche in faggio) ringhiera a pannelli di  
vetro curvo, stratificato e temprato  
mm 10+10 di colore naturale C0002.  
Disponibile con sistema di illuminazione Led (optional)

Staircase of lamelled oak wood, colour 410 cacao ■  
(available also in beech wood).  
Banister of bent glass panels, stratified and tempered  
glass 10+10, natural colour C0002.  
Option Led system available.



▼ **FLY XC**



◀ **FLY XR**

Scala in legno di rovere lamellare tinta 410 cacao (disponibile anche in faggio).  
Ringhiera a pannelli retti di vetro stratificato e temprato mm 10+10, colore C0002 naturale.

Staircase of lamelled oak wood, colour 410 cacao (available also in beech wood).  
Banister of straight glass panels, stratified and tempered glass 10+10, natural colour C0002.

|← mm →| 700 ÷ 900

■ Portata scala: kg 400/m<sup>2</sup>  
Altezza massima della scala mm 3500

■ Load capacity: kg. 400/ m<sup>2</sup>  
Staircase height up to mm 3500

**AKURA XC**  
*scale con il vetro*  
*glass staircases*

glass  
series

Scala con gradini in rovere lamellare spessore 50 mm, tinta naturale 253 (disponibile anche in faggio).  
Ringhiera a pannelli di vetro curvo stratificato e temprato mm 10+10 di colore extrachiaro.

Staircase of lamelled oak wood, 50 mm thickness, natural colour 253 (available also in beech wood).  
Banister of bent glass panels, stratified and tempered glass 10+10, extralight colour.

|← mm →| 700 ÷ 900

**AKURA XR**  
*scale con il vetro*  
*glass staircases*



Scala con gradini in rovere lamellare spessore 50 mm, tinta naturale 253 (disponibile anche in faggio).  
Ringhiera a pannelli di vetro retto, stratificato e temprato mm 10+10 di colore extrachiaro.

Staircase of lamelled oak wood treads, 50 mm thickness, natural colour 253 (available also in beech wood).  
Banister of straight glass panels, stratified and tempered glass 10+10, extralight colour.

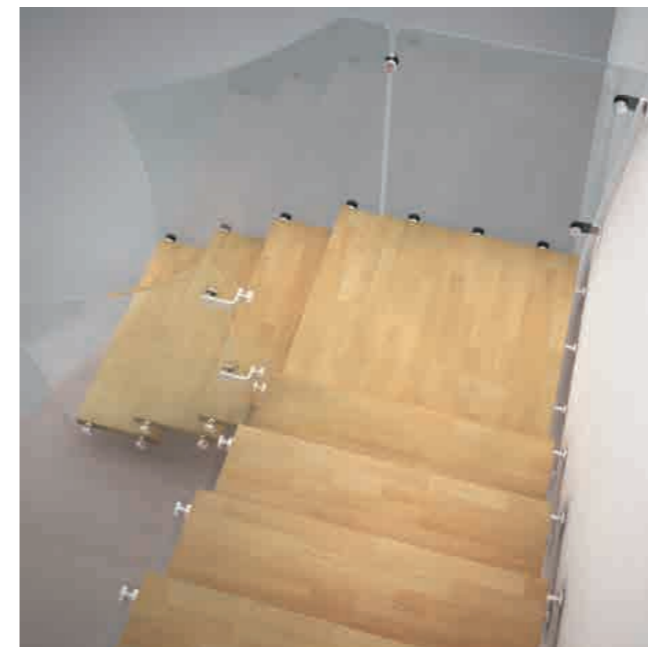

|← mm →| 700 ÷ 900

Portata scala: kg 400/m<sup>2</sup>  
Altezza massima della scala mm 4500

Load capacity: kg. 400/ m<sup>2</sup>  
Staircase height up to mm 4500

▲ **AKURA XC**



**AKURA GLASS**  
*scaie con il vetro*  
*glass staircases*

glass  
series

La nuova interpretazione Mobirolo del vivere contemporaneo: una scala dalle forme grafiche realizzate in solidi materiali di carattere, come l'acciaio e il vetro temprato nei tre colori trasparente, bianco e fumé; la tecnologia d'avanguardia per spazi sempre più flessibili ed elementi decorativi che durano nel tempo.

The new interpretation of Mobirolo for contemporary living. A staircase with graphic shapes, made of solid materials as chrome steel and the tempered glass in three different tones: transparent, white and fumé. A cutting-edge technology to create a long lasting interior decoration, for living spaces of the future more and more flexible and opened to the space.

23

Scala a giorno con gradini in vetro temprato e stratificato.  
Ringhiera RX in acciaio inox 304.  
Colore vetro: C0002 naturale

Open staircase with tempered, stratified glass treads.  
RX banister of inox 304.  
Glass colour: C0002 natural.

|← mm →| 500 ÷ 1000

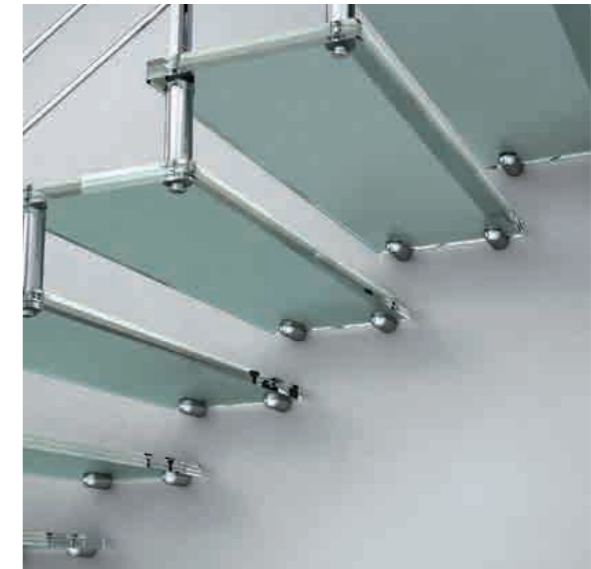

### Ricorda...

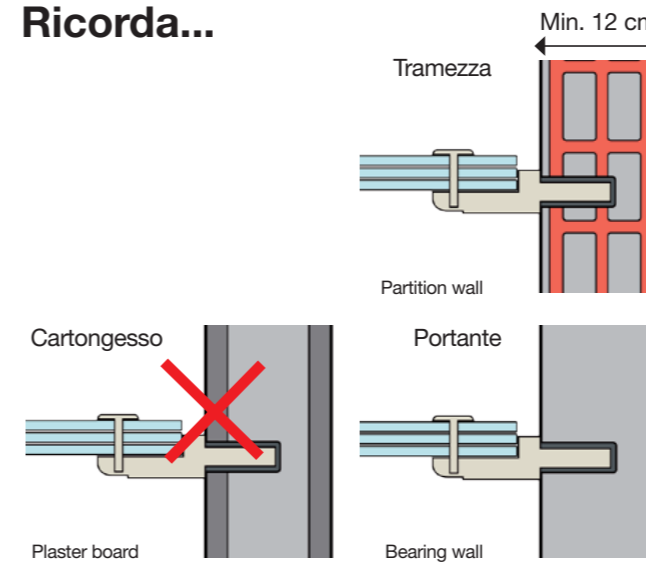

■ Ricorda di verificare che la tipologia del muro sia tra quelle indicate a fianco. L'installazione di una scala AKURA GLASS richiede il fissaggio su tramezza o muro portante. Solo queste tipologie possono garantire il corretto ancoraggio per un'adeguata distribuzione dei pesi e delle trazioni.

■ Remind to check the similarity of your wall to one of the cases here indicated. The installation of the open staircase AKURA GLASS needs an anchorage on a bearing wall or a partition one. Only these typologies of wall, can assure a correct anchorage and an adequate distribution of weights and tractions.

### ◀ AKURA GLASS

Scala a giorno con gradini in vetro temprato e stratificato.  
Ringhiera RX in acciaio inox 304. Colore vetro: C0005 grigio fumé.

Open staircase with tempered, stratified glass treads.  
RX banister of inox 304. Glass colour: C0005 grey-fumé.



**DIABLE GLASS**  
*scale con il vetro*  
*glass staircases*



Un nuovo modo di attraversare lo spazio. ■  
 È la creatività Mobirolo che si rinnova, in un perfetto equilibrio di linee e abbinamenti cromatici. Materiali sapientemente plasmati come l'acciaio cromato e il vetro temprato, fanno di Diable Glass un complemento di arredo unico e sofisticato, protagonista assoluto dello spazio abitativo contemporaneo.

By renewed creativity, Mobirolo conceives a ■  
 different way to cross the space, in a perfect balance of colour combinations and shapes. Materials cleverly mixed, as chrome steel and tempered glass, make Diable Glass a unique and sophisticated complement for interiors. An absolute protagonist for contemporary living spaces.

■ Portata scala: kg 400/m<sup>2</sup>  
 Altezza massima della scala mm 4100

■ Load capacity: kg. 400/ m<sup>2</sup>  
 Staircase height up to mm 4100

Scala a chiocciola con gradini in vetro temprato e stratificato. Ringhiera chrome, distanziali e corrimano in acciaio cromato. Colore vetro: C0002 Naturale. Disponibile con distanziali e corrimano in legno nella versione DIABLE GLASS L.

Spiral stair with tempered, stratified glass treads. Chrome banister, handrail and spacers. Glass colour: C0002 natural. Available also with wooden spacers and handrail with the version DIABLE GLASS L

Ø 1120 - 1220 - 1320 - 1420 - 1520 - 1620 mm



## scale a giorno modulari

Modular open stairs

### Perché scegliere una Scala a Giorno Modulare Mobirolo?

Why choose a Mobirolo Modular Open Staircase?

modular

#### **Disegnate su di te.**

Ogni nostro modello è progettato sulle tue misure e sul tuo spazio, lasciandoti ampia libertà di scelta tra finiture e materiali di qualità.

#### **Una solida sicurezza.**

Solidità della struttura garantita da una portata di 400 kg/mq.

#### **Adattabili al tuo spazio.**

Le nostre scale si adattano ottimamente allo spazio grazie a pedata ed alzata fatte a misura per la massima comodità possibile.

#### **Scegli il tuo stile.**

Ampia possibilità di scelta di materiale, design, colore e finiture.

#### **Designed around you.**

Every model we design is made to measure your space, and leaves you with extensive choice among finishes and quality materials.

#### **Solid and dependable.**

The solid structure is guaranteed by the 400-kg/m<sup>2</sup> capacity.

#### **Adapts to your space.**

Our staircases adapt perfectly to space thanks to bespoke riser and tread, for the highest possible comfort.

#### **Choose your style.**

A wide selection of materials designs, colours and finishes.

#### **Le soluzioni per la ringhiera.**

La ringhiera è disponibile in diversi design e materiali: con colonnine in acciaio verniciato o acciaio cromato, oppure con tubi orizzontali.

#### **Coordiniamo il gusto.**

La balaustra è realizzata con gli stessi elementi che compongono la ringhiera della scala.

#### **L'innovazione della luce.**

Scopri i modelli in cui è disponibile il sistema di illuminazione a LED automatizzato.

#### **Cura dell'ambiente.**

Attenzione a salute e ambiente grazie alla verniciatura "ad acqua" del legno.

#### **The solutions for your banister.**

The banister is available in several designs and materials: with painted or chromed steel columns or horizontal rods.

#### **Combining taste with consistency.**

The balustrade is made of the same elements as the banister.

#### **Lighting innovation.**

Find out about the models featuring the automated LED lighting system.

#### **Care for the environment.**

Care for health and the environment thanks to our "water-based" painted wood.

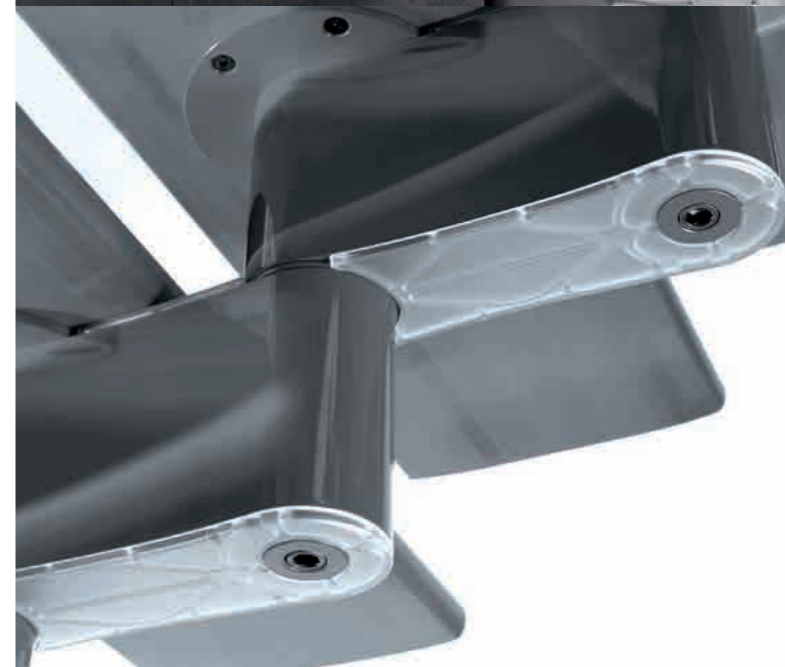

 mobirolo



## NIKA CHROME

*Scale a giorno modulari*  
*Modular open stairs*



Nika è la massima espressione dell'innovazione tecnica nel design verticale Mobirolo. Si caratterizza per la struttura portante realizzata con un profilo di alluminio ad altissime prestazioni in termini di portata e leggerezza. La forma essenziale e sinuosa dei suoi moduli la rende unica, capace di rispondere alle più sofisticate esigenze architettoniche grazie all'ampia gamma di finiture e colori. Le parti in legno sono in massello di faggio o rovere. Design a cura dello studio Binini e Denti.

Nika is the highest expression of technical innovation in Mobirolo's vertical design. It stands out for the supporting structure and its top performance aluminium profile in terms of capacity and lightness. The essential and winding shape of its modules makes it truly unique and capable to cater to the most sophisticated architectural requirement also thanks to the broad range of colours and finishes. The wooden parts are either solid beech or oak. Design by Studio Binini and Denti.

Struttura di colore bianco (extra serie),  
gradini in faggio lamellare tinta 305S bianco spazzolato.  
Corrimano e ringhiera cromati.

White structure (extra range), finger joint beech  
treads in 305S brushed white.  
Chrome handrail and chrome banister.

|← mm →| 700 ÷ 1000

## NIKA SC

*Scale a giorno modulari*  
*Modular open stairs*



Struttura e ringhiera in metallo grigio 7015, gradini e corrimano in legno tinta 289 doussié.



Metal structure and banister in 7015 grey, wooden handrail and treads in 289 doussié colour.

33

|← mm →| 700 ÷ 1000

## ◀ NIKA CZ

Struttura e ringhiera in metallo grigio 97RG, gradini e corrimano in legno tinta 311 sbiancato.

Metal structure and banister in 97RG grey, wooden treads and handrail in 311 whitened colour.

|← mm →| 700 ÷ 1000



## NUVOLA CHROME

*Scale a giorno modulari  
Modular open stairs*



Nuvola si adatta al tuo ambiente con leggerezza e linee morbide. I moduli e i gradini sono disegnati con curve armoniose, con forme arrotondate e piacevoli. La misura dell'alzata e della pedata sono regolabili, così da potersi inserire al meglio nei tuoi spazi. Le parti in legno sono in massello di faggio.

Nuvola adapts to your room with lightness and smooth lines. The module and treads are designed with well-proportioned curves and rounded, pleasant shapes. The riser and tread are adjustable in order to better adapt to the space. The wooden parts are solid beech.

Struttura, gradini e corrimano in legno tinta 311 sbiancato. Ringhiera cromata.

Wooden structure, treads and handrail in 311 whitened wood. Chrome banister.

|← mm →| 700 ÷ 1000



◀ **NUVOLA SC**

Struttura, gradini e corrimano in legno tinta 289 doussié. Ringhiera in metallo grigio 97RG.

Wooden structure, treads and handrail in colour 289 doussié. Metal banister in grey 97RG.

|← mm →| 700 ÷ 1000



▲ **NUVOLA CZ**

Struttura, gradini e corrimano in legno tinta 287 ciliegio. Ringhiera in metallo grigio 97RG.

Wooden structure, treads and handrail in colour 287 cherry. Metal banister in grey 97RG.

|← mm →| 700 ÷ 1000



## JAZZ CHROME LED

*Scale a giorno modulari  
Modular open stairs*

modular

Jazz è il prototipo di scala intelligente. ■

La sua struttura è costituita da elementi in acciaio regolabili in alzata ed in pedata: questo consente una straordinaria capacità di adattamento alle dimensioni del tuo spazio.

Il sistema Led (optional) è disponibile in tutte le scale modello Jazz.

Jazz is the prototype of a smart staircase. ■

Its structure is made of steel elements adjustable in terms of riser and tread: this allows an extraordinary ability to adapt to the size of your room.

Led system (optional) is available for all the types of Jazz stairs.



Struttura in metallo verniciata grigio raggrinzato 97RG; gradini e corrimano in legno tinta grigio 400; ringhiera cromata.

Metal painted structure in wrinkled grey 97RG; wooden treads and handrail colour grey 400; chrome banister.

|← mm →| 600 ÷ 950



## JAZZ CHROME LED

*Scale a giorno modulari*  
*Modular open stairs*



Struttura in metallo verniciata ■  
grigio raggrinzato 97RG;  
gradini e corrimano in legno  
tinta 311 sbiancato. Ringhiera cromata.

Metal painted structure in wrinkled grey 97RG; ■  
wooden treads and handrail  
in 311 whitened colour. Chrome banister.

41

|← mm →| 600 ÷ 950

# IL DESIGN ILLUMINA LA SICUREZZA

The design highlights the security

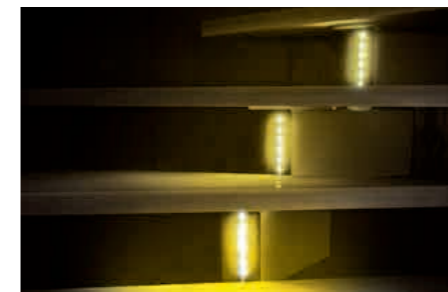

**Sistema integrato**  
L'impianto elettrico a 12 volt è totalmente integrato nella scala.

**Attivazione automatica dell'illuminazione**  
Due sensori attivano l'accensione, non si richiede alcun pulsante.

**Sensori luce ambiente**  
L'accensione si attiva solo in situazione di luce prestabilita e selezionata dall'utente.

**Sorgente luminosa LED**  
Basso consumo, con intensità e colore (RGB system) regolabili da telecomando.

**Attivazione timer**  
Tempo di attivazione luci al passaggio sulla scala.

**Luce di emergenza**  
Una batteria garantisce l'illuminazione in caso di blackout elettrico.

**Più sicurezza per tutti**  
La luce di emergenza estende l'illuminazione all'ambiente circostante.

**Telecomando**  
Colori ed intensità della luce, accensione e spegnimento manuale.

**Integrated system**  
The electric system of 12 volt is totally integrated into the stair.

**Automatic lighting activation**  
The lighting occurs by two sensors, without external switch.

**Lighting sensors**  
The lighting will be activated according to the parameters defined by the user.

**LED light system**  
Low consumption, colour and intensity adjustment (RGB System ) by remote control.

**Timer activation**  
The lighting activation to be settled during the stair crossing.

**Emergency light**  
A battery will assure the light in case of electric blackout.

**More security for everybody**  
The emergency headlamp lights the environment.

**Remote control**  
To regulate the colours and the light intensity, the manual switch on /off.

■ Portata scala: kg 400/m<sup>2</sup>  
Altezza massima della scala mm 3500

■ Load capacity: kg. 400/ m<sup>2</sup>  
Staircase height up to mm 3500







## JAZZ CHROME LED

*Scale a giorno modulari*  
*Modular open stairs*



### SISTEMA ILLUMINAZIONE SOTTOSCALA A FARETTI ■

Corpo illuminante a led (RGB system) con proiettore verticale inserito nel modulo portante; elemento opzionale non collegato alla temporizzazione del passaggio scala. Si possono prevedere più faretti in rapporto allo spazio da illuminare.

### LIGHTING SYSTEM UNDER STAIR BY LED HEADLAMP ■

Led Headlamp vertical lighting (RGB System) inserted in the stair beam; optional element, independent from the general timing activation of the stair lighting. Further headlamps can be added, according to the area to light up.



**JAZZ FX**

*Scale a giorno modulari  
Modular open stairs*

Struttura e ringhiera in metallo bianco 90RG. ■  
Gradini e corrimano in legno, tinta 253 naturale.

Metal structure and banister in white 90RG. ■  
Wooden treads and handrail  
in 253 natural colour.





## JAZZ SC

Scale a giorno modulari  
Modular open stairs



Struttura e ringhiera in metallo bianco 90RG. ■  
Gradini e corrimano in legno,  
tinta 421DEC sabbia décapé.

Metal structure and banister in white 90RG. ■  
Wooden treads and handrail  
in colour 421DEC sand decapé.



## scale a giorno in legno

Wooden open staircases

### Perché scegliere una Scala a Giorno in Legno Mobirolo?

Why choose a Mobirolo wooden Open Staircase?

open

#### **Disegnate su di te.**

Ogni nostro modello viene dimensionato in base alle misure del tuo spazio. Si adatta al tuo ambiente lasciandoti ampia libertà di scelta tra finiture e materiali di qualità.

#### **Una solida sicurezza.**

Solidità della struttura garantita da una portata di 400 kg/m<sup>2</sup>.

#### **A misura di bambino.**

Lo spazio vuoto tra le colonne della ringhiera è sempre inferiore a 10 cm, come previsto dalla normativa per la sicurezza dei bambini.

#### **Calcolo della pedata costante.**

Le scale sono progettate in modo che i gradini risultino tutti della stessa profondità: solo così si garantisce una pedata costante sull'asse di camminamento, per la massima comodità possibile.

#### **Un pezzo unico.**

Le Strutture portanti della scala sono realizzate in un unico pezzo, senza elementi di giunzione, per un design pulito e lineare (fatto salvo esigenze di progetto).

#### **Designed around you.**

Every model we make is sized to the measures of your space. It adapts to your environment and leaves you with extensive choice among finishes and quality materials.

#### **Solid and dependable.**

The solid structure is guaranteed by the 400-kg/m<sup>2</sup> capacity.

#### **Made to measure for children.**

The empty space between the banister columns is always lower than 10 cm, as prescribed in the regulation for children's safety.

#### **Steady and consistent tread.**

The staircases are designed in a way that all steps have the same depth: this is the only way to ensure a consistent tread on the walking line for the highest possible comfort.

#### **Single-piece structure.**

The supporting structures of the staircase are made with a single piece, without any jointing elements, for a clean and linear design (except for particular project requirements).

#### **Un design armonioso.**

Questa serie di scale si caratterizza per un design armonico delle strutture portanti, fatto di linee morbide ed ondulate.

#### **Il valore nei dettagli.**

Cura e definizione dei dettagli, con i gradini incassati nella struttura e nessun elemento di fissaggio strutturale a vista.

#### **Scegli il tuo stile.**

Ampia possibilità di scelta di materiale e design per ringhiera e balaustra.

#### **Coordiniamo il gusto.**

La balaustra è realizzata con gli stessi elementi che compongono la ringhiera della scala.

#### **L'innovazione della luce.**

Scopri i modelli in cui è disponibile il sistema di illuminazione a LED automatizzato.

#### **Cura dell'ambiente.**

Attenzione a salute e ambiente grazie alla verniciatura "ad acqua" del legno.

#### **Well-proportioned design.**

This staircase series stands out for a well-proportioned structural design made of smooth and winding lines.

#### **Value is in the details.**

Care and definition of details, with steps cased in the structure and no structural fastening element in sight.

#### **Choose your style.**

A broad selection of materials and designs available for the banister and handrail.

#### **Combining taste with consistency.**

The banister is made of the same elements as the banister along the steps.

#### **Lighting innovation.**

Find out about the models featuring the automated LED lighting system.

#### **Care for the environment.**

Care for health and the environment thanks to out "water-based" painted wood.





## MANTIS

*Scale a giorno  
Open staircases*



Mantis è la scala pensata per valorizzare gli ambienti più ricercati grazie alla raffinatezza della ringhiera in acciaio, perfetto connubio tra eleganza e design. La struttura e i gradini donano alla scala una linea armonica e possono essere realizzati in legno di faggio o rovere. I pannelli sono disponibili nei colori bianco raggrinzato, nero raggrinzato, grigio raggrinzato, gold e corten. Disponibile anche con sistema di illuminazione Led.

Mantis, the stair designed to enhance the most refined living spaces thanks to the elegance of the steel banister, a perfect combination between sophistication and design. The structure and the treads give to the stair an harmonious shape and they are available in beech wood or oak wood. The panels are available in these colours: wrinkled white, wrinkled black, wrinkled grey, gold and corten. Also available with Led lighting system.

53

Scala in legno di faggio tinta 410 cacao.  
Ringhiera in acciaio colore gold.

Wooden beech stair in 410 cacao colour.  
Steel banister in gold colour.

|← mm →| 700 ÷ 1000



GALLERY  
ONLINE

## CASTLE

*Scale a giorno  
Open staircases*



Maestosa ed elegante al tempo stesso, Castle ■  
saprà sedurre gli amanti della modernità nel  
rispetto della tradizione. La ringhiera si fonde  
completamente nella struttura divenendone parte  
integrante, dando vita ad un complemento di  
arredo adatto anche al living più contemporaneo.  
Disponibile anche con sistema di illuminazione Led.

Castle, a majestic and elegant stair able to seduce ■  
the innovation lovers by respecting the tradition.  
The banister is totally integrated into the structure  
and makes Castle a sophisticated complement  
for the most contemporary living spaces.  
Also available with Led lighting system.

Scala in legno di rovere, tinta 410 cacao spazzolato.

Oak wooden stair in 410 brushed cacao colour.

|← mm →| 700 ÷ 1000



GALLERY  
ONLINE

**CASTLE Z**  
*Scale a giorno*  
*Open staircases*



Ringhiera e struttura in un unico pannello ■  
che segue, nella parte inferiore,  
l'andamento geometrico dei gradini.  
Disponibile anche con sistema di illuminazione Led.

The banister and the structure combine ■  
in a unique panel that follows the geometric  
trend of the treads in the lower side.  
Also available with Led lighting system.

57

Scala in legno tinta 305S bianco spazzolato.

Wooden stair in 305S brushed white colour.

|← mm →| 700 ÷ 1000



## VERTIGO INOX

*Scale a giorno  
Open staircases*



La scala Vertigo ha una caratteristica che la rende unica: ■  
si possono salire i suoi gradini senza mai staccare la  
mano dal corrimano. Questo è possibile grazie alla  
forma curva della colonna di raccordo tra le rampe e  
lo stesso corrimano, elemento che dona eleganza e  
raffinatezza al design dell'intera struttura.

There is one feature to the Vertigo staircase that ■  
makes it truly unique: it can be climbed for its entire  
length without taking the hand off the handrail.  
This is possible thanks to the column connecting the  
ramp and the handrail, an elegant and  
sophisticated element that brings out the design  
appeal of the entire structure.

Scala in legno tinta sbiancata 311,  
ringhiera a colonne inox.

Wooden staircase, colour whitened wood  
311, banister with inox spindles.

|← mm →| 700 ÷ 1000



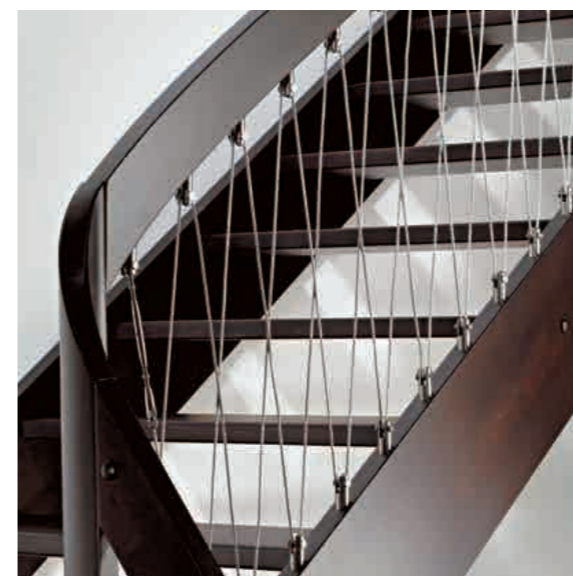
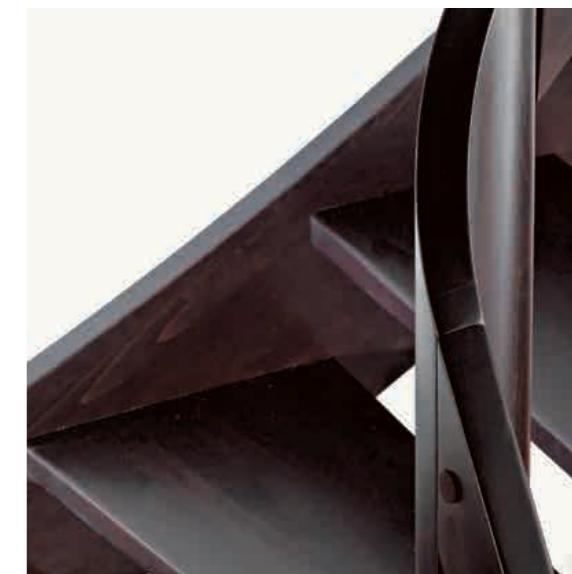
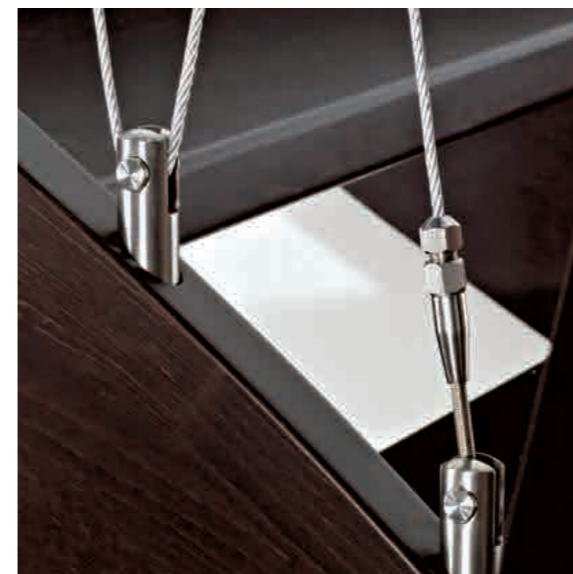

◀ **VERTIGO**

Scala in legno tinta wengè 312, ringhiera a cavi in acciaio.

Wooden stair, colour 312 wengè, banister with steel cables.

|← mm →| 700 ÷ 1000



## ESPERIA CHROME LED

*Scale a giorno*  
*Open staircases*



Scala in legno di rovere lamellare tinta 410S ■  
cacao spazzolato, ringhiera cromata.  
Il sistema Led è disponibile come optional per  
tutte le varianti del modello Esperia.

Stair of finger joint oak wood, brushed ■  
cacao 410S colour, chrome banister.  
Led system (optional) is available for  
all the types of Esperia stairs.

|← mm →| 650 ÷ 1000



63

Gradini a passo costante: unica profondità  
della pedata per una percorrenza sempre  
sicura e confortevole.

Treads with constant going for more  
comfort and top safety.

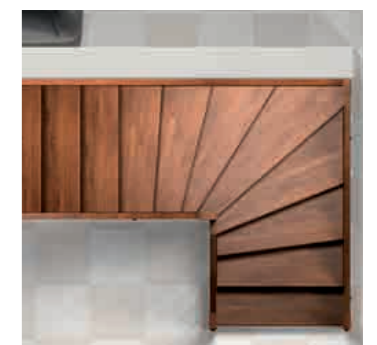

# IL DESIGN ILLUMINA LA SICUREZZA

The design highlights the security

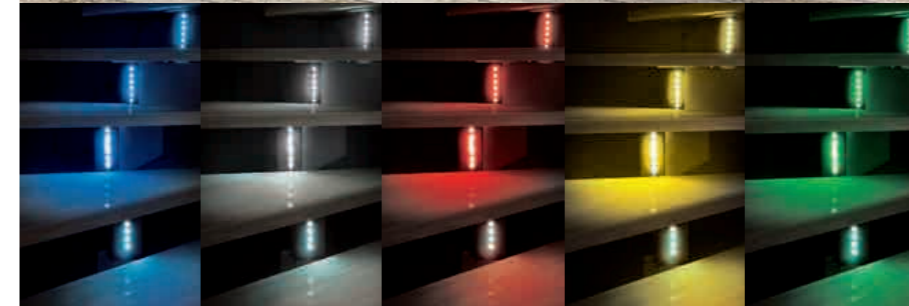

**Sistema integrato**

L'impianto elettrico a 12 volt è totalmente integrato nella scala.

**Attivazione automatica dell'illuminazione**

Due sensori attivano l'accensione, non si richiede alcun pulsante.

**Sensori luce ambiente**

L'accensione si attiva solo in situazione di luce prestabilita e selezionata dall'utente.

**Sorgente luminosa LED**

Basso consumo, con intensità e colore (RGB system) regolabili da telecomando.

**Attivazione timer**

Tempo di attivazione luci al passaggio sulla scala.

**Luce di emergenza**

Una batteria garantisce l'illuminazione in caso di blackout elettrico.

**Più sicurezza per tutti**

La luce di emergenza estende l'illuminazione all'ambiente circostante.

**Telecomando**

Colori ed intensità della luce, accensione e spegnimento manuale.

**Integrated system**

The electric system of 12 volt is totally integrated into the stair.

**Automatic lighting activation**

The lighting occurs by two sensors, without external switch.

**Lighting sensors**

The lighting will be activated according to the parameters defined by the user.

**LED light system**

Low consumption, colour and intensity adjustment (RGB System ) by remote control.

**Timer activation**

The lighting activation to be settled during the stair crossing.

**Emergency light**

A battery will assure the light in case of electric blackout.

**More security for everybody**

The emergency headlamp lights the environment.

**Remote control**

To regulate the colours and the light intensity, the manual switch on /off.

■ Portata scala: kg 400/m<sup>2</sup>  
Altezza massima della scala mm 3500

■ Load capacity: kg 400/m<sup>2</sup>  
Staircase height up to mm 3500



## ESPERIA COLLEGE

*Scale a giorno  
Open staircases*



Esperia è la soluzione ideale per chi cerca in una scala in legno, un elegante elemento di arredo che caratterizzi il proprio ambiente. Sono modelli concepiti e costruiti per durare nel tempo, in massello di faggio o rovere. Disponibile anche con sistema di illuminazione a LED.

Esperia is the ideal solution for those who seek a wooden staircase, a furniture element to give character to the ambience. These solid beech and oak models are designed to last. Also available with LED lighting system.

Scala in legno tinta 311 sbiancato, ringhiera con colonne in metallo grigio 97RG.

Wooden stair in 311 whitened colour, banister with metal spindles in grey 97RG.

|← mm →| 650 ÷ 1000

Gradini a passo costante: unica profondità della pedata per una percorrenza sempre sicura e confortevole.

Treads with constant going for more comfort and top safety.

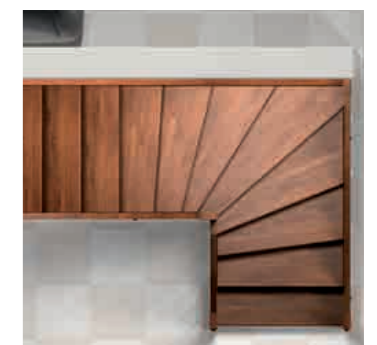



## ESPERIA CÀ D'ORO

*Scale a giorno*  
*Open staircases*



Scala e colonne in legno tinta grigio 400. ■  
Disponibile con optional alzate chiuse.



Wooden stair and spindles in colour 400 grey. ■  
Available with closed riser as optional.

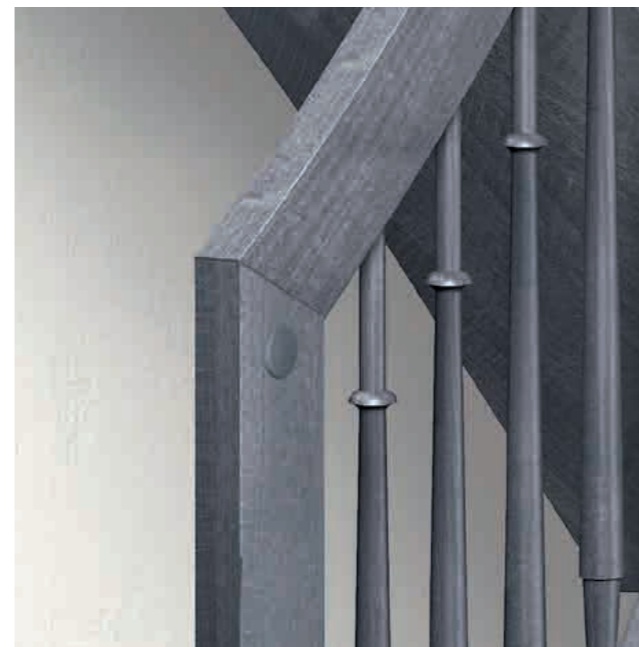

|← mm →| 650 ÷ 1000

Gradini a passo costante: unica profondità della pedata per una percorrenza sempre sicura e confortevole.

Treads with constant going for more comfort and top safety.

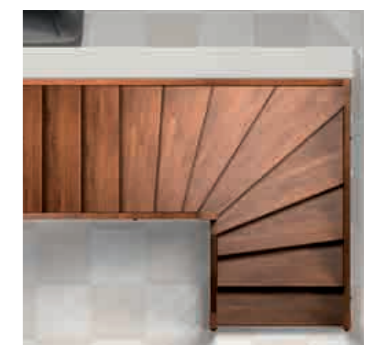

**ESPERIA VISCAL**

*Scale a giorno  
Open staircases*



Scala in legno di faggio tinta 305S bianco spazzolato. ■  
Ringhiera con colonne in metallo nero 95RG.

Wooden beech stair in 305S brushed white colour. ■  
Banister with metal spindles in black 95RG.

71

|← mm →| 650 ÷ 1000

Gradini a passo costante: unica profondità  
della pedata per una percorrenza sempre  
sicura e confortevole.

Treads with constant going for more  
comfort and top safety.

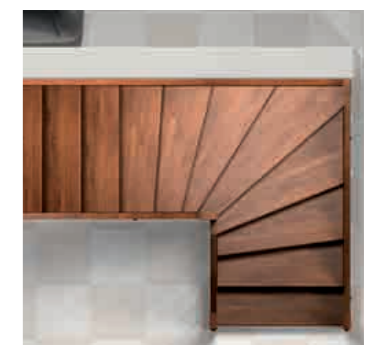

ESPERIA VISCONTEA

Scale a giorno  
Open staircases



Scala in legno tinta 258 rovere. ■  
Ringhiera con colonne in metallo nero 95RG.

Wooden stair in 258 oak colour. ■  
Banister with metal spindles in black 95RG.

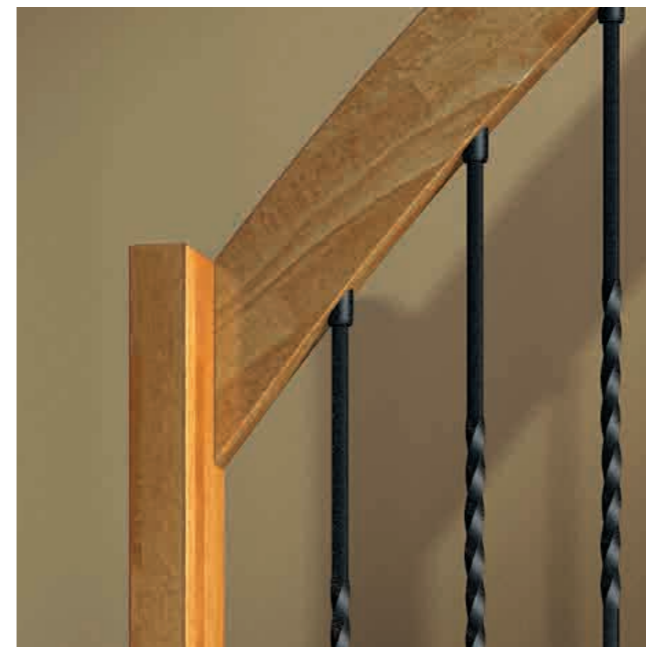

|← mm →| 650 ÷ 1000

Gradini a passo costante: unica profondità  
della pedata per una percorrenza sempre  
sicura e confortevole.

Treads with constant going for more  
comfort and top safety.

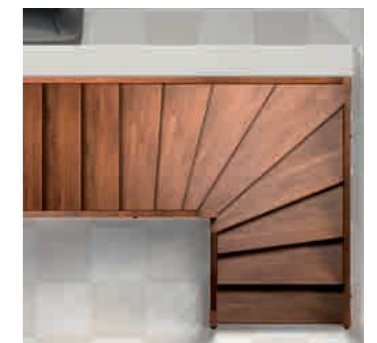



▼ **ESPERIA NOVECENTO**

Scala e colonne in legno tinta sbiancata 311.  
Wooden stair and spindles in 311 whitened colour.

|← mm →| 650 ÷ 1000



Gradini a passo costante:  
unica profondità della pedata  
per una percorrenza sempre  
sicura e confortevole.

Treads with constant going  
for more comfort  
and top safety.

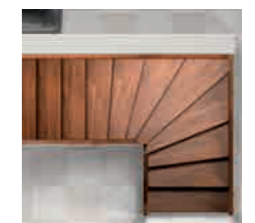

◀ **ESPERIA OLD ENGLAND**

Scala e colonne in legno tinta noce medio 252.  
Wooden stair and spindles in 252 light walnut colour.

|← mm →| 650 ÷ 1000





## ESPERIA FLY PLUS LED

*Scale a giorno  
Open staircases*



Scala in legno di rovere lamellare tinta 420S sabbia spazzolato, ringhiera a colonne cromate. Il sistema Led è disponibile come optional per tutte le varianti del modello Esperia Fly.

Stair of finger joint oak wood in 420S brushed sand colour. Banister with chrome spindles. Led system is available for all types of Esperia stairs as optional.

|← mm →| 700 ÷ 900



77

Gradini a passo costante: unica profondità della pedata per una percorrenza sempre sicura e confortevole.

Treads with constant going for more comfort and top safety.

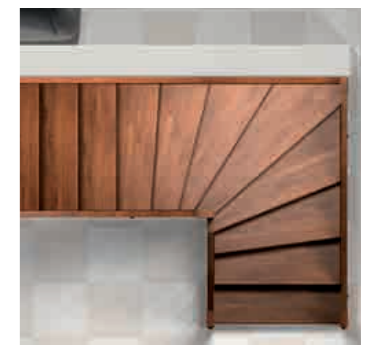

# IL DESIGN ILLUMINA LA SICUREZZA

The design highlights the security

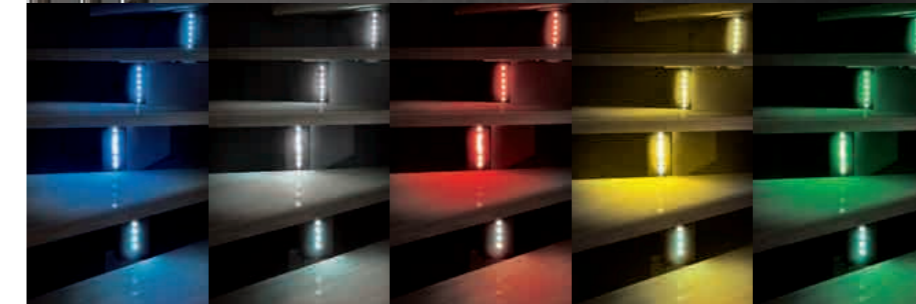

**Sistema integrato**  
L'impianto elettrico a 12 volt è totalmente integrato nella scala.

**Attivazione automatica dell'illuminazione**  
Due sensori attivano l'accensione, non si richiede alcun pulsante.

**Sensori luce ambiente**  
L'accensione si attiva solo in situazione di luce prestabilita e selezionata dall'utente.

**Sorgente luminosa LED**  
Basso consumo, con intensità e colore (RGB system) regolabili da telecomando.

**Attivazione timer**  
Tempo di attivazione luci al passaggio sulla scala.

**Luce di emergenza**  
Una batteria garantisce l'illuminazione in caso di blackout elettrico.

**Più sicurezza per tutti**  
La luce di emergenza estende l'illuminazione all'ambiente circostante.

**Telecomando**  
Colori ed intensità della luce, accensione e spegnimento manuale.

**Integrated system**  
The electric system of 12 volt is totally integrated into the stair.

**Automatic lighting activation**  
The lighting occurs by two sensors, without external switch.

**Lighting sensors**  
The lighting will be activated according to the parameters defined by the user.

**LED light system**  
Low consumption, colour and intensity adjustment (RGB System) by remote control.

**Timer activation**  
The lighting activation to be settled during the stair crossing.

**Emergency light**  
A battery will assure the light in case of electric blackout.

**More security for everybody**  
The emergency headlamp lights the environment.

**Remote control**  
To regulate the colours and the light intensity, the manual switch on /off.

■ Portata scala: kg 400/m<sup>2</sup>  
Altezza massima della scala mm 3500

■ Load capacity: kg 400/m<sup>2</sup>  
Staircase height up to mm 3500



## ESPERIA FLY CHROME

*Scale a giorno  
Open staircases*



Nei modelli FLY si incontrano il passato ed il futuro di ■  
Mobirolò. L'esperienza della fabbricazione  
di scale a giorno combinata  
con elementi dal design contemporaneo.  
Le parti in legno di massello di faggio o rovere si  
fondono con la leggerezza dei componenti metallici.  
Disponibile anche con sistema di illuminazione a LED.

The future and past of Mobirolò meet in the FLY ■  
models. The experience in manufacturing open  
staircases combined with contemporary design  
elements. The solid beech or oak elements match  
perfectly with the lightness of the metal components.  
Also available with LED lighting system.

Scala in legno tinta grigio 400,  
ringhiera a colonne cromate.

Wooden beech stair in 400 grey colour.  
Banister with chrome spindles.

|← mm →| 700 ÷ 900

Gradini a passo costante: unica profondità  
della pedata per una percorrenza sempre  
sicura e confortevole.

Treads with constant going for more  
comfort and top safety.

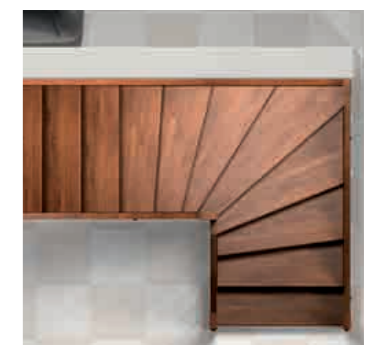

**AKURA RX**  
*Scale a giorno*  
*Open staircases*



Akura è la scala a giorno disegnata per gli ambienti moderni, che esigono un elevato standard qualitativo di design e materiali. La ricerca della forma minimale trova la sua espressione con il sistema di sospensione dei gradini, fissati direttamente al muro senza la necessità di ulteriori strutture di sostegno.

Akura is the open staircase thought for contemporary spaces, where high quality level of design and materials is a must. The search of the essential shape is played thanks to the treads hanging system, directly fixed to the wall, without further support structures.

Gradini in faggio lamellare spessore 50 mm,  
tinta 430 tortora.  
Ringhiera inox  
Disponibile con optional alzate chiuse.  
Finger joint beech treads in 430 dove grey colour,  
thickness 50 mm. Inox banister.  
Available with closed riser as optional.

|← mm →| 500 ÷ 1000



## AKURA CHROME

*Scale a giorno*  
*Open staircases*



Gradini, caposcala e corrimano in legno  
di faggio lamellare, spessore 50 mm  
tinta 420 sabbia. Ringhiera cromata.

Treads, newel post and handrail of finger joint  
beech in 420 sand colour.  
Treads thickness of 50 mm. Chrome banister.



## SOLUZIONI A MURO DOVE LA QUALITÀ SI VEDE

Wall fixing solutions where quality is evident

*L'esperienza Mobirolo offre più soluzioni.*

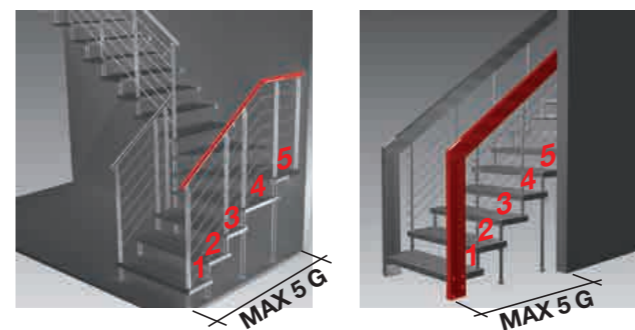

G = gradini – treads

■ L'esperienza Mobirolo offre più soluzioni. AKURA è stata studiata per favorire l'installazione anche negli spazi che presentassero discontinuità del muro. La struttura prevede la possibilità di aggiunta di una porzione di ringhiera per un tratto massimo di 5 gradini.

■ The Mobirolo experience proposes different solutions. AKURA has been styled thinking also to the spaces where there is not wall continuity. The structure foresees the possibility to add a banister section, up to 5 treads extent.

**Ricorda...**

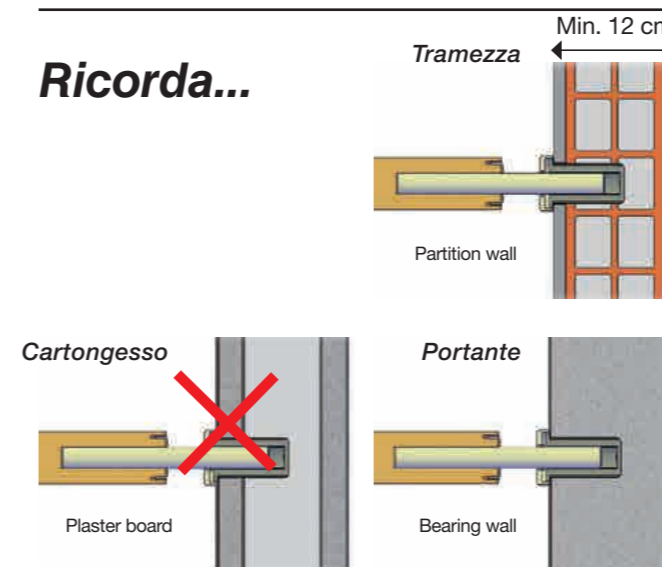

■ Ricorda di verificare che la tipologia del muro sia tra quelle indicate a fianco. L'installazione di una scala AKURA richiede il fissaggio su tramezza o muro portante. Solo queste tipologie possono garantire il corretto ancoraggio per un'adeguata distribuzione dei pesi e delle trazioni.

■ Remind to check the similarity of your wall to one of the cases here indicated. The installation of the open staircase AKURA needs an anchorage on a bearing wall or a partition one. Only these typologies of wall, can assure a correct anchorage and an adequate distribution of weights and tractions.

■ Portata scala: kg 400/m<sup>2</sup>  
Altezza massima della scala mm 4500

■ Load capacity: kg. 400/ m<sup>2</sup>  
Staircase height up to mm 4500

## AKURA HR

*Scale a giorno*  
*Open staircases*



Akura HR è caratterizzata dal notevole spessore ■  
del gradino di 80 mm che garantisce elevate  
prestazioni e un tono d'impatto deciso,  
adattabile ad ogni tipo d'ambiente.  
Il gradino è appoggiato direttamente alla parete.

Akura HR foresees a tread thickness of 80 mm, ■  
in order to guarantee high performances;  
it is adapt to any type of environment.  
The tread is directly leaned to the wall.

89

Gradini in faggio lamellare spessore 80 mm  
tinta 305S bianco spazzolato.  
Ringhiera cromata bianco 90RG.

Finger joint beech treads in 305S brushed white colour.  
Treads thickness of 80 mm.  
Chrome banister in white 90RG.

|← mm →| 700 ÷ 900



# SOLUZIONI A MURO DOVE LA QUALITÀ SI VEDE

Wall fixing solutions where quality is evident

## L'esperienza Mobirolo offre più soluzioni.

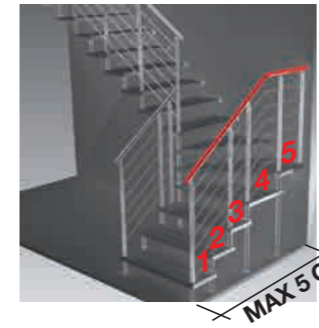

G = gradini – treads

- L'esperienza Mobirolo offre più soluzioni. AKURA HR è stata studiata per favorire l'installazione anche negli spazi che presentassero discontinuità del muro. La struttura prevede la possibilità di aggiunta di una porzione di ringhiera per un tratto massimo di 5 gradini.
- The Mobirolo experience proposes different solutions. AKURA HR has been styled thinking also to the spaces where there is not wall continuity. The structure foresees the possibility to add a banister section, up to 5 treads extent.

## Ricorda...

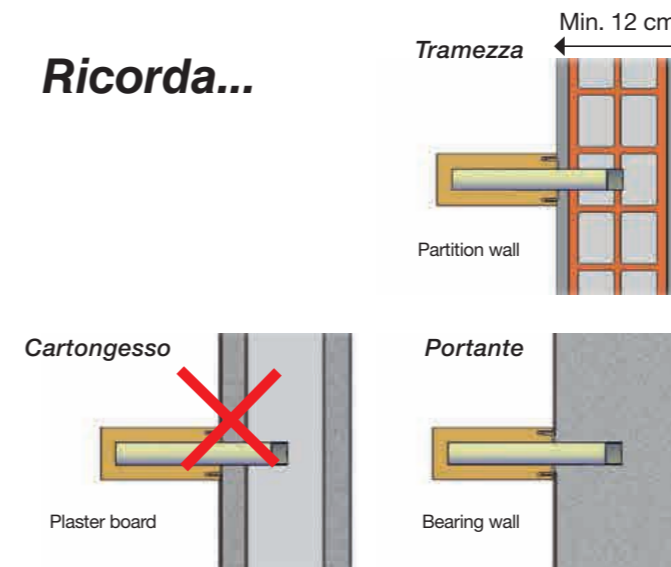

- Ricorda di verificare che la tipologia del muro sia tra quelle indicate a fianco. L'installazione di una scala AKURA HR richiede il fissaggio su tramezza o muro portante. Solo queste tipologie possono garantire il corretto ancoraggio per un'adeguata distribuzione dei pesi e delle trazioni.
- Remind to check the similarity of your wall to one of the cases here indicated. The installation of the open staircase AKURA HR needs an anchorage on a bearing wall or a partition one. Only these typologies of wall, can assure a correct anchorage and an adequate distribution of weights and tractions.

■ Portata scala: kg 400/m<sup>2</sup>  
Altezza massima della scala mm 4500

■ Load capacity: kg. 400/ m<sup>2</sup>  
Staircase height up to mm 4500



## REXAL CHROME

*Scale a giorno*  
*Open staircases*



L'acciaio della struttura Rexal viene tagliato con la precisione del laser, in un processo di lavorazione mirato ad ottenere uno standard qualitativo elevato e senza compromessi. Il risultato è una scala dalle alte prestazioni di portata con un design essenziale, ma di forte carattere.

The steel structure is sculpted by the laser perfection, to obtain a high level of quality, without compromise. The result is a stair of high performances in terms of solidity, essential design and strong personality.

93

Struttura verniciata effetto Corten COR80, gradini in faggio lamellare tinta noce spazzolato 252S, corrimano e ringhiera chrome.

Painted structure Corten COR80 effect, finger joint beech treads 252S brushed walnut color. Chrome handrail and chrome banister.

|← mm →| 700 ÷ 1000

REXAL CZ

*Scale a giorno*  
*Open staircases*



Struttura verniciata nero raggrinzato 95RG, ■  
gradini in faggio lamellare  
tinta 390S nero spazzolato. Corrimano cromato,  
ringhiera a colonne verniciate nero 95RG.

Painted structure in 95RG wrinkled black, ■  
finger joint beech treads in 390S  
brushed black colour. Chrome handrail,  
banister with painted spindles in black 95RG.

95

|← mm →| 700 ÷ 1000



## GAMMA CZ

Scale a giorno  
Open staircases



Leggerezza e luminosità: ■  
sulla struttura portante in acciaio verniciato si  
appoggiano gradini in legno lamellare di faggio;  
il tutto armoniosamente accompagnato dal  
corrimano nelle varianti in legno o acciaio.  
Varianti disponibili: sc, cz, chrome.  
È disponibile solo in Italia.

Staircase available for Italy only. ■

### ◀ GAMMA CZ

Gradini e corrimano tinta rovere 258. Struttura e colonne ringhiera grigio raggrinzato 97RG.

|← mm →| 500 ÷ 1000

## scale per piccoli spazi

Staircases for small spaces

### Perché scegliere una Scala per Piccoli Spazi Mobirolò?

Why choose a Mobirolò  
Staircase for Small Spaces?

#### **Misurate sul tuo spazio.**

Ogni modello viene dimensionato in base all'altezza dei tuoi piani, lasciandoti ampia libertà di scelta tra finiture e materiali di qualità.

#### **Una solida sicurezza.**

Solidità della struttura garantita da una portata di 400 kg/mq.

#### **A misura di bambino.**

Lo spazio vuoto tra le colonne della ringhiera è sempre inferiore a 10 cm, come previsto dalla normativa per la sicurezza dei bambini.

#### **Scegli il tuo stile.**

Ampia possibilità di scelta di finiture e colori per la ringhiera e gli altri elementi.

#### **Coordiniamo il gusto.**

La balaustra di protezione del foro al piano di arrivo è realizzata con gli stessi elementi che compongono la ringhiera della scala.

#### **Cura dell'ambiente.**

Attenzione a salute e ambiente grazie alla verniciatura "ad acqua" del legno.

#### **Measures around you space.**

Every model is sized depending on the height of the floors, thus leaving room to choose the finished and quality materials.

#### **Solid and dependable.**

The solid structure is guaranteed by the 400-kg/m2 capacity.

#### **Made to measure for children.**

The empty space between the banister columns is always lower than 10 cm, as prescribed in the regulation for children's safety.

#### **Choose your style.**

A wide selection of finishes and colours for the banister and the other elements.

#### **Combining taste with consistency.**

The floor protection balustrade is made of the same elements used for the banister along the steps.

#### **Care for the environment.**

Care for health and the environment thanks to our "water-based" painted wood.

small



 **mobirolò**



DIXI

*Scale per piccoli spazi*  
Staircases for small spaces



Dixi è una soluzione moderna e brillante per gli spazi ridotti. La struttura portante è costituita da elementi in acciaio regolabili che garantiscono l'adattamento alle dimensioni in altezza del piano. Il design dei gradini è ottimizzato per consentire una superficie di appoggio adeguata per percorrere la scala in sicurezza e contenere gli ingombri.

Dixi is a modern and brilliant solution for reduced spaces. The supporting structure is made of adjustable steel elements that ensure perfect adaptability to the size and height of the floor. The step design is optimised to provide a suitable walkover surface, walk the staircase safely and keep the encumbrance to a low.

101

Struttura e ringhiera in metallo 97RG grigio raggrinzato.  
Gradini e corrimano in legno tinta 311 sbiancato.

Metal structure and banister in 97RG wrinkled grey.  
Wooden treads and handrail in 311 whitened colour.

|← mm →| 593

**MIGNON**

*Scale per piccoli spazi  
Staircases for small spaces*

▼ **MARINARA**

Scala in legno tinta 410 cacao. Ringhiera con colonne in metallo grigio 97RG.

Wooden stair in 410 cacao colour. Banister with metal spindles in grey 97RG.

|← mm →| 500 ÷ 700

Mignon è la scala a tre dimensioni, ■  
piccola nelle misure ma con un  
grande carattere.  
Si compone combinando 3 rampe  
realizzata su misura  
per il tuo spazio.  
La larghezza è adattabile  
da 500 mm fino a 700 mm.

Mignon is a three-dimensional ■  
staircase, small in size  
but with a big heart.  
It is made of 3 flights made to  
measure around your space.  
Its width is adjustable from  
500 mm to 700 mm.



◀ **MIGNON**

Scala in legno tinta 400 grigio. Ringhiera con colonne in metallo nero 95RG.

Wooden stair in 400 grey colour. Banister with metal spindles in black 95RG.

|← mm →| 500 ÷ 700



## scale a chiocciola

Spiral staircases

### Perché scegliere una Scala a Chiocciola Mobirolo?

Why choose a Mobirolo Spiral Staircase?

spiral

#### **Misurate sul tuo spazio.**

Ogni modello viene dimensionato in base all'altezza dei tuoi piani, lasciandoti ampia libertà di scelta tra finiture e materiali di qualità.

#### **Una solida sicurezza.**

Solidità della struttura garantita da una portata di 400 kg/mq.

#### **Abbiamo tutti i tuoi numeri.**

Un'ampia gamma di larghezze: undici varianti di serie, da un minimo di 100 cm a un massimo di 200 cm.

#### **A misura di bambino.**

Lo spazio vuoto tra le colonne della ringhiera è sempre inferiore a 10 cm, come previsto dalla normativa per la sicurezza dei bambini.

#### **Made to measure around your space.**

Every model is sized depending on the height of the floors, thus leaving room to choose the finished and quality materials.

#### **Solid and dependable.**

The solid structure is guaranteed by the 400-kg/m<sup>2</sup> capacity.

#### **We have all your numbers.**

A broad range of lengths: eleven series versions, from a minimum of 100 cm to a maximum of 200 cm.

#### **Made to measure for children.**

The empty space between the banister columns is always lower than 10 cm, as prescribed in the regulation for children's safety.

#### **Il valore nei dettagli.**

Il gradino di arrivo al piano superiore è più largo per consentire un accesso più confortevole e sicuro.

#### **Scegli il tuo stile.**

Ampia possibilità di scelta di finiture e colori per la ringhiera e gli altri elementi.

#### **Coordiniamo il gusto.**

La balaustra di protezione del foro al piano di arrivo è realizzata con gli stessi elementi che compongono la ringhiera della scala.

#### **Cura dell'ambiente.**

Attenzione a salute e ambiente grazie alla verniciatura "ad acqua" del legno.

#### **Value is in the details.**

The landing step on the upper floor is wider to ensure more comfort and safety.

#### **Choose your style.**

A wide selection of finishes and colours for the banister and the other elements.

#### **Combining taste with consistency.**

The floor protection balustrade is made of the same elements used for the banister along the steps.

#### **Care for the environment.**

Care for health and the environment thanks to our "water-based" painted wood.





## PURA LED

### Scale a chiocciola Spiral staircases



Un oggetto di design e arredo curato ■  
per esaltare il bello e la funzionalità.  
Questa scala è caratterizzata da una struttura  
elicoidale senza palo centrale, arricchita da un  
sostegno verticale che aiuta la percorrenza della scala.  
Ringhiera Chrome con colonne cromate  
Ø 30 mm e sette tondini da Ø 8 mm.  
Corrimano in metallo cromato o legno.  
Realizzabile in legno di Faggio o Rovere.  
Disponibile con sistema di illuminazione Led (optional).

Stair that is an object of design and interior for ■  
intensifying the beauty and the functionality.  
This stair is characterized by an helicoidally  
structure without the central pole and it is  
enriched by a vertical support in order to facilitate  
the going up of the stair. Chrome banister with  
chrome spindles Ø 30 mm and 7 rods Ø 8 mm.  
Chrome metal or wood handrail.  
Available in beech or oak wood.  
Option Led system available.

107

Scala e corrimano in faggio lamellare  
tinta bianco spazzolato 305S,  
ringhiera cromata.

Stair and handrail of finger joint  
beech wood, 305S brushed white.  
Chrome banister.

Diametri disponibili essenza faggio:  
Available diameters in beech wood:

Ø 1300 - 1400 - 1500 - 1600  
- 1700 - 1800 - 1900 - 2000 mm



**PURA**  
*Scale a chiocciola*  
*Spiral staircases*



Scala in rovere lamellare tinta ■  
Sabbia 421 dec, corrimano  
e ringhiera cromata.  
Disponibile anche in faggio.

Stair of finger joint oak wood, ■  
421 dec sand color.  
Chrome handrail and chrome banister.  
Available also in beech wood.



Diametri disponibili essenza rovere:  
Available diameters in oak wood:  
Ø 1300 - 1400 - 1500 - 1600 mm



**DIABLE MT**  
*Scale a chiocciola*  
*Spiral staircases*



In Diable trovano la loro massima espressione due caratteristiche a cui Mobirolo tiene particolarmente: l'attenzione ai dettagli e la ricerca sulla qualità dei materiali. La ringhiera si compone di colonne verticali in acciaio cromato e da tondini in acciaio inox. Il corrimano è disponibile sia nelle varianti di legno che in acciaio. Tutti i componenti in metallo sono cromati. Gli accessori sono fabbricati in lega di alluminio.

Diable is where two characteristics Mobirolo holds particularly dear express themselves: attention for details and material quality research. The banister features vertical chromed columns and stainless steel rods. The handrail is available either in the wood or steel versions. All metal components are chromed. The accessories, in turn, are made of aluminium alloy.



Ø 1100 - 1200 - 1300 - 1400 - 1500 - 1600 mm

Gradini e corrimano in legno, tinta 430 tortora. Ringhiera e distanziali cromati.

Wooden treads and handrail in 430 dove colour. Chrome banister and spacers.



**DIABLE QMT**  
*Scale a chiocciola*  
*Spiral staircases*



Scala in legno ■  
tinta sabbia decapato 421dec;  
corrimano, ringhiera e distanziali cromati.

Wooden stair in 421 dec ■  
sand décapé colour.  
Chrome handrail, banister and spacers.

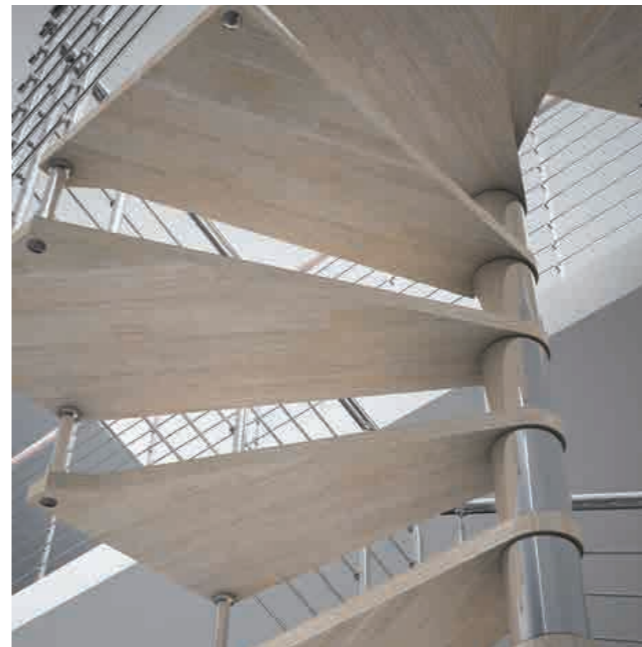



**DIABLE RED LINE**  
*Scale a chiocciola*  
*Spiral staircases*



Gradini, corrimano e distanziali in legno di faggio 350 rosso Mobirolo. Ringhiera chrome.

Beech wooden treads, handrail and spacers in 350 Red Mobirolo colour. Chrome banister.



115

Ø 1100 - 1200 - 1300 - 1400  
1500 - 1600 - 1700 - 1800  
1900 - 2000 mm

**DIABLE T**

◀ Gradini, corrimano e distanziali in legno di faggio 253 naturale. Ringhiera chrome.

Wooden treads, handrail and spacers in 253 natural beech colour. Chrome banister.

**GHIBLI**  
*Scale a chiocciola*  
*Spiral staircases*



**GHIBLI Q**



Scala e corrimano in legno ■  
 tinta wengè 312,  
 colonne in metallo grigio 97RG.

Wooden stair and handrail ■  
 in 312 wengè colour.  
 Metal spindles in grey 97RG.

117

∅ 1100 - 1200 - 1300 -  
 1400 - 1500 - 1600 mm

**GHIBLI**

Scala e corrimano in legno tinta grigio 400, colonne in metallo grigio 97RG.

Wooden stair and handrail in 400 grey colour. Metal spindles in grey 97RG.

∅ 1100 - 1200 - 1300 - 1400 - 1500 - 1600 - 1700 - 1800 - 1900 - 2000 mm



## FOX GREY

*Scale a chiocciola  
Spiral staircases*



In Fox si uniscono vivacità e solidità. ■

La parte centrale di sostegno è in acciaio verniciato, i gradini sono in legno massello di faggio. La ringhiera in acciaio verniciato è composta da 3 colonne verticali per gradino. Il corrimano è ottenuto da un profilo estruso in PVC.

Fox combines solidity and liveliness. ■

The central supporting portion is made of painted steel, the steps are solid beech wood. The steel banister is made of 3 vertical columns per step. The handrail is made of an extruded PVC profile.

Scala in legno tinta tortora 430, corrimano pvc grigio, colonne in metallo grigio raggrinzato 97RG.

Wooden stair in 430 dove grey colour.  
PVC handrail in grey colour,  
metal spindles in 97RG wrinkled grey.

Ø 1100 - 1200 - 1300 - 1400 - 1500 - 1600 mm



**VIP T**  
*Scale a chiocciola*  
*Spiral staircases*



Vip è una scala a chiocciola che sa farsi notare. Sia la parte centrale di sostegno che i gradini sono realizzati in legno massello di faggio. Il corrimano è ottenuto da un profilo estruso in PVC ed è disponibile in colorazione effetto legno. La ringhiera in acciaio verniciato è composta da 3 colonne verticali per gradino.

Vip is a spiral staircase that won't go unnoticed. Both the central supporting part and the steps are made of solid beech wood. The handrail is made of an extruded PVC profile, also available in the wood-effect pattern. The painted steel banister features 3 columns per step.

Scala in legno tinta 252 noce medio, corrimano in pvc effetto legno. Colonne in metallo grigio 97RG.

Wooden stair in 252 light walnut colour, pvc handrail with wood effect. Metal spindles in grey 97RG.

Ø 1100 - 1200 - 1300 - 1400 - 1500  
 1600 - 1700 - 1800 - 1900 - 2000 mm

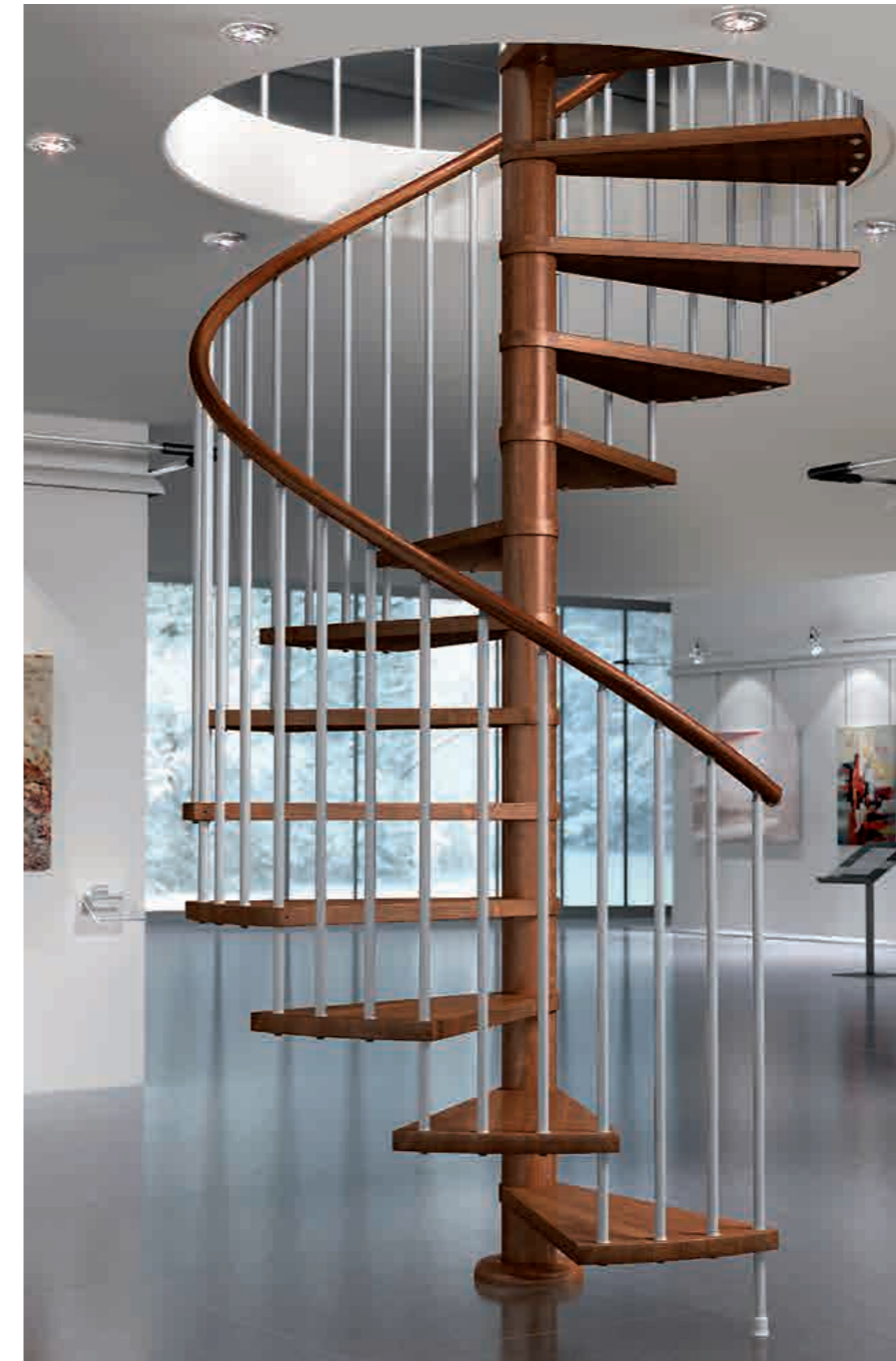

◀ **FOX T**

Scala in legno tinta 253 naturale, corrimano in pvc effetto legno. Colonne e distanziali in metallo grigio 97RG.

Wooden stair in 253 natural beech colour, pvc handrail with wood effect. Metal spindles and spacers in grey 97RG.

Ø 1100 - 1200 - 1300 - 1400 - 1500 - 1600 mm

**SILVER FX**  
*Scale a chiocciola*  
*Spiral staircases*



Gradini e corrimano in legno tinta ■  
289 doussié e distanziali in metallo.  
Ringhiera a colonne in metallo grigio  
97RG e cavi in acciaio inox.

Wooden treads and handrail in ■  
289 doussié colour, metal spacers.  
Banister with metal spindles in grey  
97RG and stainless steel cables.

Ø 1100 - 1200 - 1300 - 1400 - 1500 - 1600 mm





**STAR 04**  
*Scale a chiocciola*  
*Spiral staircases*



Star è una scala a chiocciola ■  
con un'anima in acciaio. I gradini sono  
ottenuti tramite stampaggio.  
Il piano di calpestio è protetto da una  
pedana in PVC, con uno spessore  
importante, per garantire una tenuta  
straordinaria nel tempo.  
La ringhiera è disponibile in due versioni.  
Il corrimano è realizzato da un profilo  
estruso in PVC.

Star is a spiral staircase with a steel core. ■  
The steps are moulded. The walkover  
surface is protected by a thick PVC  
footboard that guarantees extraordinary  
durability over time.  
The banister is available in two versions.  
The handrail is made of an  
extruded PVC profile.

125

Scala in acciaio bianco 90RG.  
Corrimano, pedane e accessori in grigio.

Steel stair in white 90RG. Grey handrail,  
step-covers and accessories.



Ø 1000 - 1100 - 1200 - 1400 - 1600 mm



**STAR FX**  
*Scale a chiocciola*  
*Spiral staircases*



Scala in acciaio grigio 97RG. ■  
Corrimano, pedane e accessori in grigio.  
Ringhiera con colonne in metallo  
e cavi in acciaio inox.

Steel stair in grey 97RG. ■  
Grey handrail, step-covers and accessories.

127

Ø 1000 - 1100 - 1200 - 1400 - 1600 mm

## scale per esterno

Outdoor staircases

### Perché scegliere una Scala per esterno Mobirolo?

Why choose a Mobirolo outdoor Staircase?

out  
door

#### **Resistenti agli agenti atmosferici**

La struttura composta da elementi in acciaio zincato, garantisce un'ottima resistenza del prodotto agli agenti atmosferici.

#### **Cura dei dettagli**

Econ e Willy si differenziano per l'attenzione posta nella scelta di ogni singolo dettaglio: i corrimani in pvc offrono un design leggero e moderno e la zigrinatura ne facilita la presa.

#### **Resistant to the atmospheric agents**

The galvanized steel elements of the structure, offer a great resistance to the atmospheric agents.

#### **Care for details**

Econ and Willy stand out for the attention to the selection of each detail: the pvc handrails offer a modern design and the wrinkled effect makes the handle easier.

I gradini della Willy sono dotati di fori che favoriscono lo scolo dell'acqua, mentre le strisce adesive antiskid o in alternativa le pedane in gomma, garantiscono un elevato grado di sicurezza.

#### **Una solida sicurezza**

Solidità della struttura garantita da una portata di 400 Kg/mq

The Willy treads have holes for the water's flow, moreover, the antiskid adhesive strips or also the pvc step-covers, grant an high security level.

#### **Solid and dependable**

The solid structure is guaranteed by the 400 Kg/m<sup>2</sup> capacity.



Ø 1000 - 1100 - 1200 - 1400 - 1600 mm

Il trattamento galvanico offre un'ottima resistenza agli agenti atmosferici, ciò nonostante, non sono previste garanzie contro la corrosione.

The galvanized treatment by immersion offers an excellent resistance to atmospheric agents, nevertheless, no guarantees against corrosion are provided for outdoor versions.

## ECON FX

Scale per esterno  
outdoor staircases

out  
door

La scala per esterni Econ FX offre un'ottima resistenza agli agenti atmosferici, con finiture di alta qualità. Disponibile nella versione Z, con trattamento galvanico oppure VZ verniciata con doppio trattamento, primer «antiruggine» + verniciatura epossidica. Corrimano in PVC grigio, essenziale e moderno e con la ringhiera a 7 cavi in acciaio inox 316.

The staircase Econ FX for external use offers a great resistance to the atmospheric agents with high quality finishing. Available in Z version with galvanized treatment or in VZ version, varnished with double treatment, anti-rust primer + epoxy painting. PVC handrail of grey colour more essential and modern. Banister with 7 stainless steel 316 cables.

Scala zincata a caldo, corrimano e pedane in pvc grigio. Ringhiera con cavi in acciaio inox.

Hot galvanized stair, pvc handrail and step-cover in grey colour. Banister with cables in stainless steel.



**WILLY**

*Scale per esterno  
outdoor staircases*

out  
door

Willy, scala a rampa in metallo zincato a caldo per esterni, con finiture di alta qualità, adatta anche ad interni ricercati.

Corrimano in pvc grigio zigrinato, ringhiera a 7 cavi in acciaio inox 316. Il trattamento galvanico ad immersione offre un'ottima resistenza agli agenti atmosferici, ciò nonostante, non sono previste garanzie contro la corrosione.

Willy is the hot galvanized stair for outdoor with high quality finishing, suitable also for refined interiors. With pvc wrinkled handrail and banister with 7 cables of stainless steel 316. The galvanized treatment by immersion offers an excellent resistance to atmospheric agents, nevertheless, no guarantees against corrosion are provided for outdoor versions

131

Scala zincata a caldo, corrimano in pvc grigio. Pedane in pvc disponibili come optional.

Hot galvanized stair, pvc handrail in grey. Pvc step-cover available as optional.

|← mm →| 800 - 900

## ringhiere

Banisters for masonry staircases

### Perché scegliere una Ringhiera Mobirolo?

Why choose a Mobirolo banister?

#### **Completa la tua scala Mobirolo.**

Una linea concepita come naturale estensione della scala: le ringhiere Mobirolo sono l'elemento complementare perfetto per le nostre scale a giorno modulari.

#### **Scegli il tuo stile.**

Puoi scegliere tra un'ampia gamma di forme e materiali per abbinare lo stile della ringhiera a quello della tua scala a giorno modulare.

#### **Una solida sicurezza.**

Grandi prestazioni di portata per garantire una sicurezza che va oltre agli standard richiesti dalle normative internazionali.

#### **A misura di bambino.**

Lo spazio vuoto tra le colonne della ringhiera è sempre inferiore a 10 cm, come previsto dalla normativa per la sicurezza dei bambini.

#### **Cura dell'ambiente.**

Attenzione a salute e ambiente grazie alla verniciatura "ad acqua" del legno.

#### **Complete your Mobirolo staircase.**

A line designed as the natural extension of the staircase: Mobirolo banisters are the perfect complement for our modular open staircases.

#### **Choose your style.**

You may choose among a broad range of forms and materials to match the style of the banister to your modular open staircase.

#### **Solid and dependable.**

Unbelievable capacity to ensure safety well beyond the levels prescribed in international standards.

#### **Made to measure for children.**

The empty space between the banister columns is always lower than 10 cm, as prescribed in the regulation for children's safety.

#### **Care for the environment.**

Care for health and the environment thanks to our "water-based" painted wood.

banister



133

 mobirolo



### ▼ CHROME PX

Ringhiera cromata con tondini e pannello plexiglass trasparente anti-scaaldamento, corrimano in legno tinta 253.

Chrome banister with rods and transparent panel against climbing, wooden handrail, colour 253.

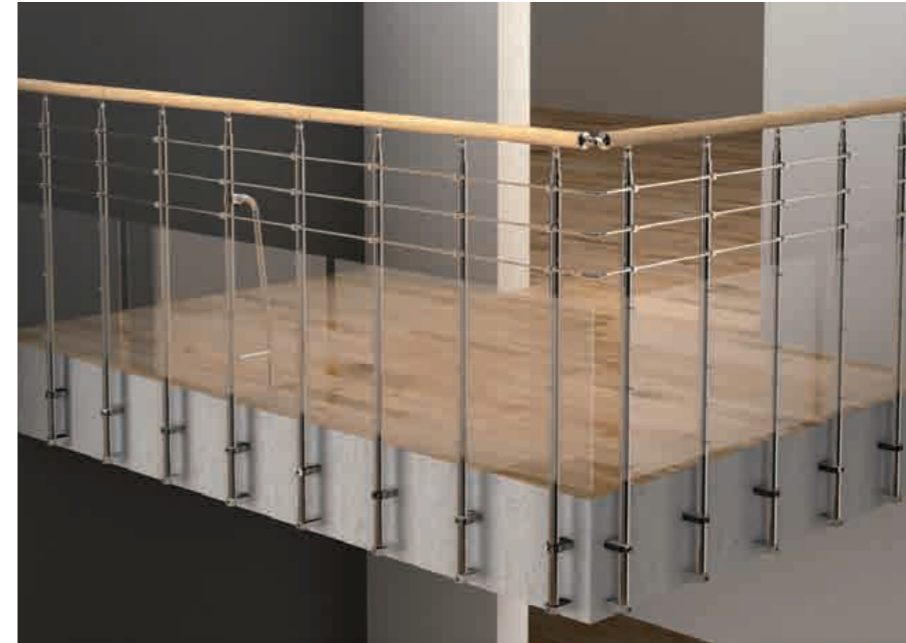

Un design lineare e raffinato, ■  
in grado di offrire un tocco  
personale ma durevole nel  
tempo ai più diversi ambienti,  
una gamma di alternative,  
colori, materiali, studiata per  
abbinarsi perfettamente a ogni  
tipo di gradino.

Uncluttered, sophisticated ■  
design, capable of giving a  
personal yet lasting touch to the  
most widely different settings,  
and a range of alternatives,  
colours and materials chosen  
to provide a perfect match with  
any type of stairs.



Ringhiera Chrome,  
variante sotto soletta.

Chrome Banister,  
under-slab version.

### ◀ CHROME

Ringhiera cromata, corrimano in legno, tinta 253.

Chrome banister, wooden handrail in 253 natural colour.

Le possibili combinazioni ■

The available combinations ■

**I CORRIMANO** *The handrail*

CZ



FX



SC

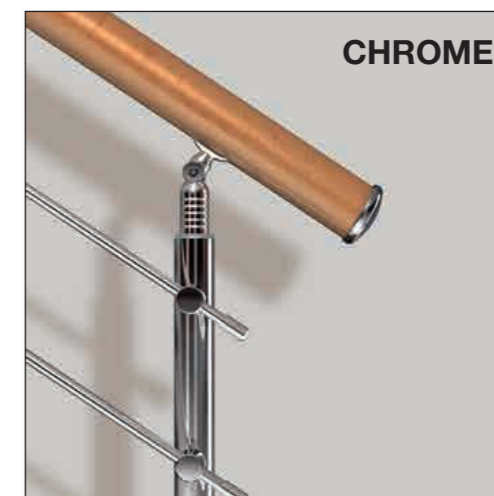

CHROME

◀ **CZ**

Colonne in metallo diam. 22, grigio 97RG,  
corrimano in legno, tinta ciliegio 287.

Metal spindles of diam. 22, grey 97RG,  
wooden handrail in 287 cherry colour.

## SCALE RIENTRANTI *Retractable stairs*

re  
trac  
table

ZX - ISO



Con una gamma di scale retrattili all'avanguardia per stabilità e sicurezza, Moberolo intende completare ogni esigenza della vostra casa. Gli esempi qui illustrati sono tratti dal catalogo specifico che potete richiedere alla nostra rete vendita. Caratteristiche principali: resistenza fino a 150 chilogrammi di carico, massima stabilità, accorgimenti esclusivi come i gradini antiscivolo, assenza di spigoli e parti taglienti, serratura contro aperture accidentali, maniglioni di sbarco per salire e scendere.

With a innovative range of retractable stairs with the highest stability and safety standards, Moberolo completes every need of your house. These examples are taken from the catalogue that you can ask to our net sale. Features: load resistance up to 150 kilograms, unmatched stability, exclusive features such as non-slip steps, no sharp edges or parts, lock to prevent accidental opening and landing handrails.



x colori di serie - standard range colours

• colori extra serie - extra range colours

## Faggio / Beech

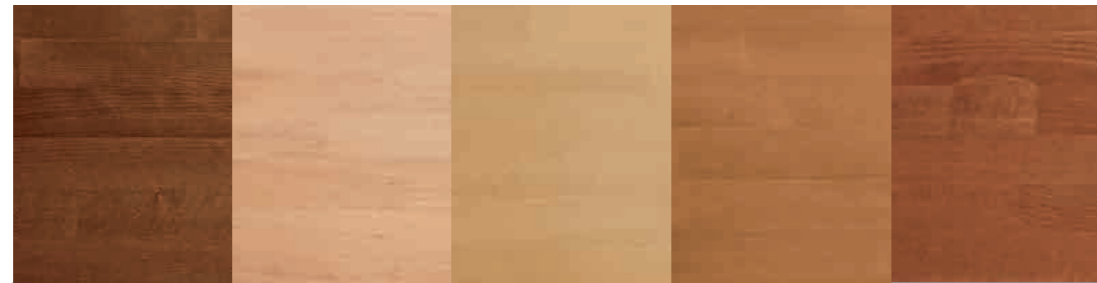

|  | <b>252</b><br>Noce medio<br>Light walnut | <b>253</b><br>Naturale<br>Natural | <b>258</b><br>Rovere<br>Oak | <b>287</b><br>Ciliegio<br>Cherry stain | <b>289</b><br>Doussié<br>Doussié |
|--|--|-----------------------------------|-----------------------------|--|----------------------------------|
|--|--|-----------------------------------|-----------------------------|--|----------------------------------|

|   |   |   |   |   |   |
|---|---|---|---|---|---|
| <b>Pura/Ghibli/Silver/<br/>Diablo/Fox Gray</b>        | X | X | X | X | X |
| <b>Vip/Fox</b>  | X | X |   |   |   |
| <b>Vertigo/Esperia/Fly/<br/>Akura/Mignon/Marinara</b> | X | X | X | X | X |
| <b>Gamma/Nika/Nuvola<br/>Jazz/Dixi/Rexal</b>          | X | X | X | X | X |
| <b>FX/Chrome/CZ</b>                                   | X | X | X | X | X |
| <b>Mantis/Castle/ Castle Z</b>                        | X | X | X | X | X |

140

## Faggio / Beech



|  | <b>430</b><br>Tortora<br>Dove grey | <b>305 S</b><br>Bianco<br>White | <b>390 S</b><br>Nero<br>Black |
|--|------------------------------------|---------------------------------|-------------------------------|
|--|------------------------------------|---------------------------------|-------------------------------|

|   |   |   |   |
|---|---|---|---|
| <b>Pura/Ghibli/Silver/<br/>Diablo/Fox Gray</b>        | • | • | • |
| <b>Vertigo/Esperia/Fly/<br/>Akura/Mignon/Marinara</b> | • | • | • |
| <b>Gamma/Nika/Nuvola<br/>Jazz/Dixi/Rexal</b>          | • | • | • |
| <b>FX/Chrome/CZ</b>                                   | • | • | • |
| <b>Mantis/Castle/ Castle Z</b>                        | • | • | • |

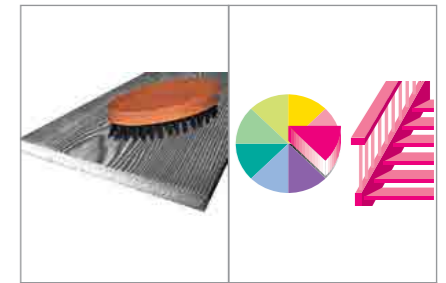

| <b>S</b> <b>Trattamento<br/>Spazzolato</b> | <b>Tinta a<br/>campione</b> |
|--|-----------------------------|
| Brushed treatment                          | Sample color                |

|   |   |
|---|---|
| • | • |
| • | • |
| • | • |
| • | • |
| • | • |

141

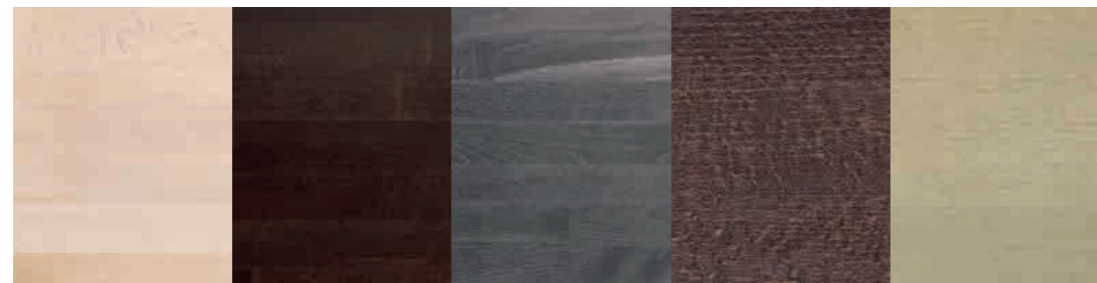

|  | <b>311</b><br>Sbiancato<br>Whitened wood | <b>312</b><br>Wengè<br>Wengè | <b>400</b><br>Grigio<br>Grey | <b>410</b><br>Cacao<br>Cacao | <b>420</b><br>Sabbia<br>Sand |
|--|--|------------------------------|------------------------------|------------------------------|------------------------------|
|--|--|------------------------------|------------------------------|------------------------------|------------------------------|

|   |   |   |   |   |   |
|---|---|---|---|---|---|
| <b>Pura/Ghibli/Silver/<br/>Diablo/Fox Gray</b>        | • | X | • | • | • |
| <b>Vertigo/Esperia/Fly/<br/>Akura/Mignon/Marinara</b> | • | X | • | • | • |
| <b>Gamma/Nika/Nuvola<br/>Jazz/Dixi/Rexal</b>          | • | X | • | • | • |
| <b>FX/Chrome/CZ</b>                                   | • | X | • | • | • |
| <b>Mantis/Castle/ Castle Z</b>                        | • | X | • | • | • |

## Décapé

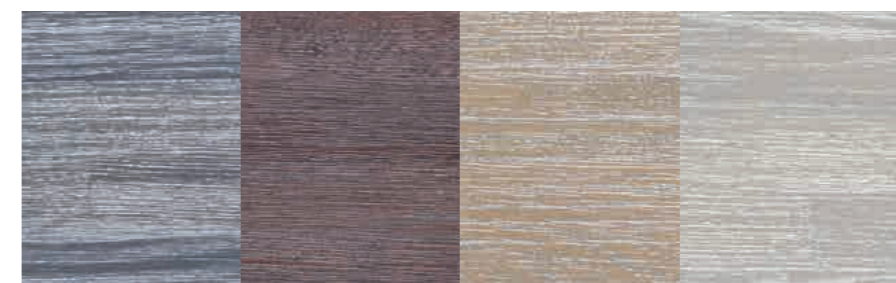

|  | <b>401 DEC</b><br>Grigio<br>Grey | <b>411 DEC</b><br>Cacao<br>Cacao | <b>421 DEC</b><br>Sabbia<br>Sand | <b>431 DEC</b><br>Tortora<br>Dove grey |
|--|----------------------------------|----------------------------------|----------------------------------|--|
|--|----------------------------------|----------------------------------|----------------------------------|--|

|   |   |   |   |   |
|---|---|---|---|---|
| <b>Pura/Ghibli/Silver/<br/>Diablo/Fox Gray</b>        | • | • | • | • |
| <b>Vertigo/Esperia/Fly/<br/>Akura/Mignon/Marinara</b> | • | • | • | • |
| <b>Gamma/Nika/Nuvola<br/>Jazz/Dixi/Rexal</b>          | • | • | • | • |
| <b>FX/Chrome/CZ</b>                                   | • | • | • | • |
| <b>Mantis/Castle/ Castle Z</b>                        | • | • | • | • |

x colori di serie - standard range colours

• colori extra serie - extra range colours

## Rovere / Oak



|  | <b>252</b><br>Noce medio<br>Light walnut | <b>253</b><br>Naturale<br>Natural | <b>287</b><br>Ciliegio<br>Cherry stain | <b>289</b><br>Doussié<br>Doussié | <b>311</b><br>Sbiancato<br>Whitened wood |
|--|--|-----------------------------------|--|----------------------------------|--|
|--|--|-----------------------------------|--|----------------------------------|--|

|  |   |   |   |   |   |
|--|---|---|---|---|---|
| Nika Chrome *  | X | X | X | X | • |
| Jazz Chrome *  | X | X |   | X |   |
| Esperia: College, Viscal, Chrome, Inox, Scaligera, Viscontea | X | X | X | X | • |
| Fly/Akura  | X | X | X | X | • |
| Rexal *  | X | X | X | X | • |
| Diable MT/QMT */Pura *                                       | X | X | X | X | • |
| Mantis/Castle/Castle Z                                       | X | X | X | X | • |

142

## Rovere / Oak

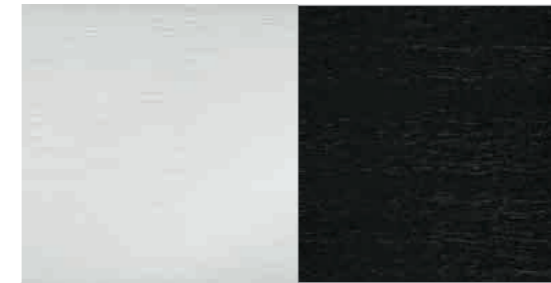

|  | <b>305 S</b><br>Bianco<br>White | <b>390 S</b><br>Nero<br>Black |
|--|---------------------------------|-------------------------------|
|--|---------------------------------|-------------------------------|

|  |   |   |
|--|---|---|
| Nika Chrome *  | • | • |
| Jazz Chrome *  | • | • |
| Esperia: College, Viscal, Chrome, Inox, Scaligera, Viscontea | • | • |
| Fly/Akura  | • | • |
| Rexal  | • | • |
| Diable MT/QMT *  | • | • |
| Mantis/Castle/Castle Z                                       | • | • |

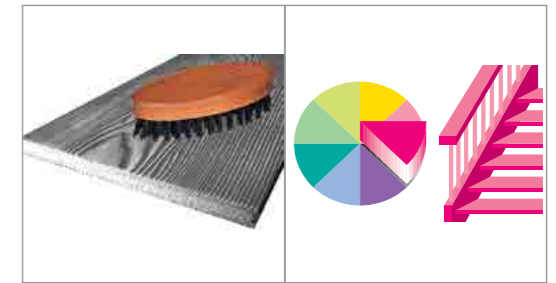

| <b>S</b> <b>Trattamento Spazzolato</b> | <b>Tinta a campione</b> |
|--|-------------------------|
| Brushed treatment                      | Sample color            |

|   |   |
|---|---|
| • | • |
| • | • |
| • | • |
| • | • |
| • | • |
| • | • |
| • | • |

143

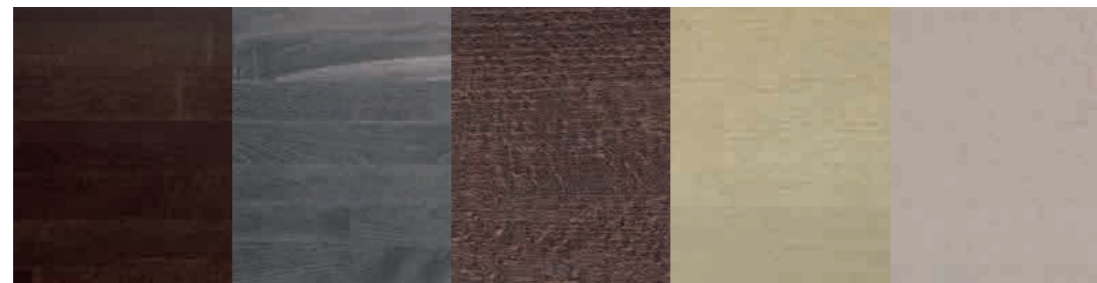

|  | <b>312</b><br>Wengè<br>Wengè | <b>400</b><br>Grigio<br>Grey | <b>410</b><br>Cacao<br>Cacao | <b>420</b><br>Sabbia<br>Sand | <b>430</b><br>Tortora<br>Dove grey |
|--|------------------------------|------------------------------|------------------------------|------------------------------|------------------------------------|
|--|------------------------------|------------------------------|------------------------------|------------------------------|------------------------------------|

|  |   |   |   |   |   |
|--|---|---|---|---|---|
| Nika Chrome *  | X | • | • | • | • |
| Jazz Chrome *  | X | • | • | • | • |
| Esperia: College, Viscal, Chrome, Inox, Scaligera, Viscontea | X | • | • | • | • |
| Fly/Akura  | X | • | • | • | • |
| Rexal *  | X | • | • | • | • |
| Diable MT/QMT */Pura *                                       | X | • | • | • | • |
| Mantis/Castle/Castle Z                                       | X | • | • | • | • |

\* solo con corrimano in metallo - with metal handrail only

I toni dei colori sono da intendersi indicativi e possono verificarsi piccole variazioni. The colors tones are to be considered as indicative and they could vary slightly.

## Décapé

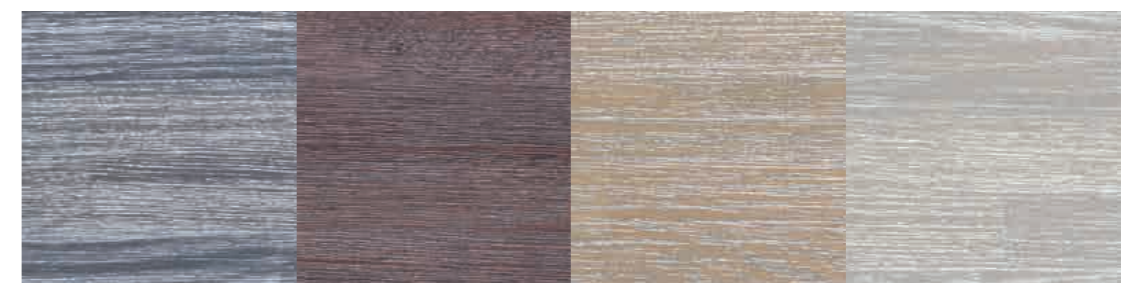

|  | <b>401 DEC</b><br>Grigio<br>Grey | <b>411 DEC</b><br>Cacao<br>Cacao | <b>421 DEC</b><br>Sabbia<br>Sand | <b>431 DEC</b><br>Tortora<br>Dove grey |
|--|----------------------------------|----------------------------------|----------------------------------|--|
|--|----------------------------------|----------------------------------|----------------------------------|--|

|  |   |   |   |   |
|--|---|---|---|---|
| Nika Chrome *  | • | • | • | • |
| Jazz Chrome *  | • | • | • | • |
| Esperia: College, Viscal, Chrome, Inox, Scaligera, Viscontea | • | • | • | • |
| Fly/Akura  | • | • | • | • |
| Rexal  | • | • | • | • |
| Diable MT/QMT *  | • | • | • | • |
| Mantis/Castle/Castle Z                                       | • | • | • | • |

\* solo con corrimano in metallo - with metal handrail only

**Il nostro trattamento Décapé / Our Décapé treatment**



**Il nostro trattamento Spazzolato / Our Brushed treatment**

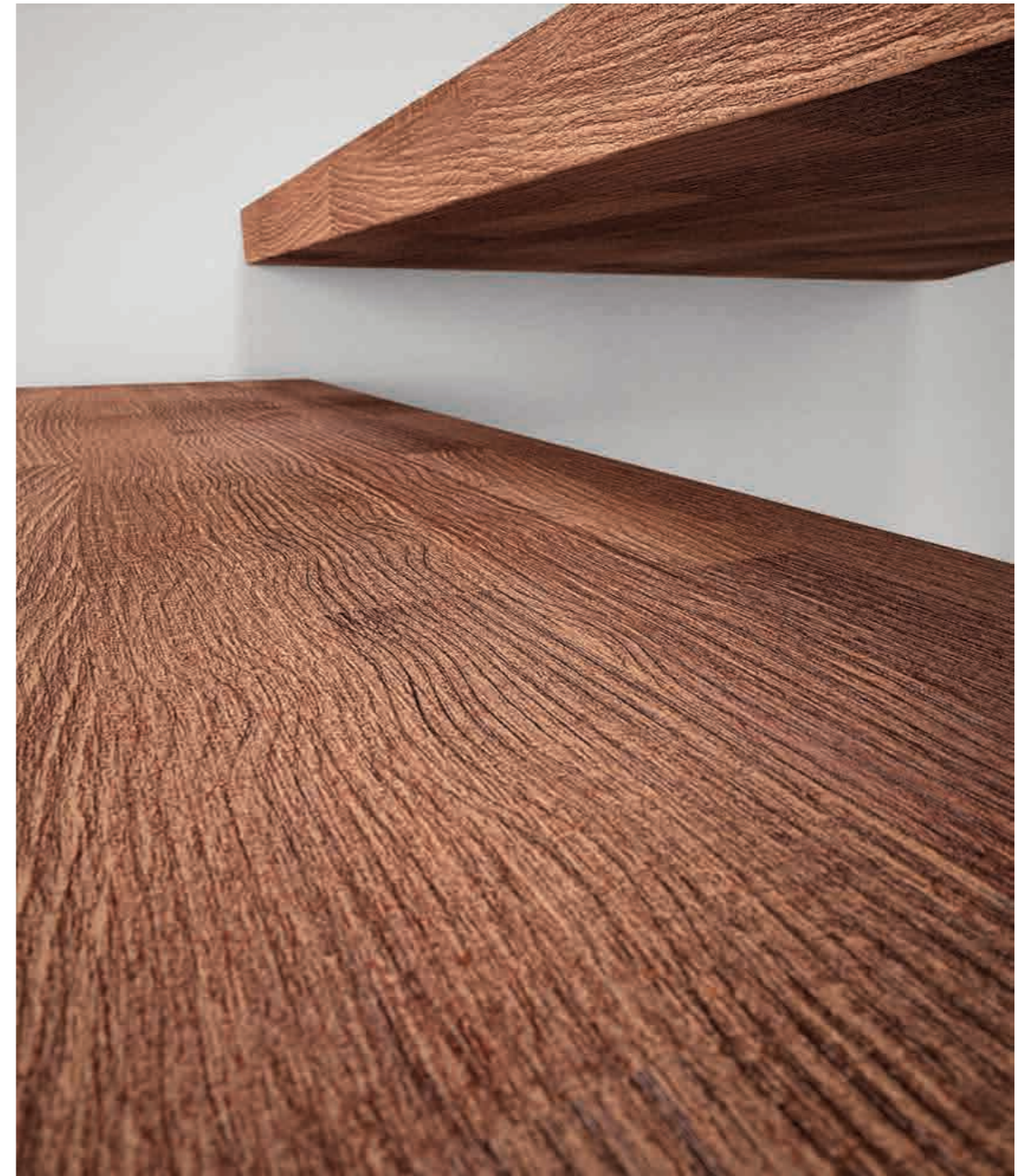





x colori di serie - standard range colours

• colori extra serie - extra range colours

IL METALLO  
Metal

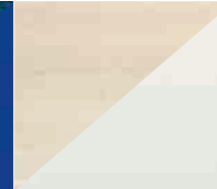

## Red Line colors: Faggio - Beech / Metal colors

|                    |  |  |  |  |  |
|--------------------|---|---|--|---|---|
|                    | <b>350/<br/>RAL 3000</b><br>Rosso Mobirolo<br>Red                                 | <b>365/<br/>RAL 1021</b><br>Giallo<br>Yellow                                      | <b>370/<br/>RAL 5002</b><br>Blu<br>Blue  | <b>380/<br/>90RG</b><br>Bianco<br>White   | <b>385/<br/>95RG</b><br>Nero<br>Black   |
| <b>Nika Chrome</b> | X   | X   | X  | X   | X   |
| <b>Jazz Chrome</b> | X   | X   | X  | X   | X   |
| <b>Diable</b>      | X   | X   | X  | X   | X   |

## Crystal colors

IL CRISTALLO  
Crystal

146

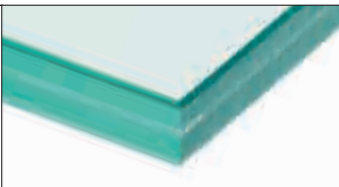
|   |   |
|---|---|
| <b>C0001</b><br>Cristallo bianco latte<br>Milky white glass |   |
| <b>C0002</b><br>Cristallo<br>Natural color glass            |  |

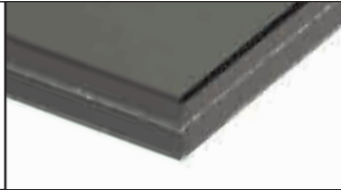
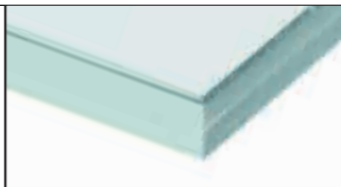
|   |   |
|---|---|
| <b>C0005</b><br>Cristallo grigio fumè<br>Grey Fumé glass    |   |
| <b>C0006</b><br>Cristallo extra chiaro<br>Extra light glass |  |

147

## Metal colors

IL METALLO  
Metal

|                        |  |  |  |  |  |
|------------------------|---|---|--|---|---|
|                        | <b>97RG</b><br>Grigio Raggrinzato<br>Wrinkled Grey                                  | <b>90RG</b><br>Bianco Raggrinzato<br>Wrinkled White                                 | <b>95RG</b><br>Nero Raggrinzato<br>Wrinkled Black                                    | <b>COR80</b><br>Effetto Corten<br>Corten effect                                       | <b>Inox</b><br>Satinato<br>Glazed   |
| <b>Akura</b>           |   |   |  |   | X   |
| <b>Esperia/Vertigo</b> |   |   |  |   | X   |
| <b>Rexal</b>           |   |   | X  | X   | •   |
| <b>Mantis</b>          | X   | X   | X  | X   |   |

I toni dei colori sono da intendersi indicativi e possono verificarsi piccole variazioni. The colors tones are to be considered as indicative and they could vary slightly.





## Metal colors

|                                   |  |  |  |       |  |
|-----------------------------------|---|---|---|--|---|
|                                   | <b>90RG</b><br>Bianco Raggrinzato<br>Wrinkled White                                 | <b>95RG</b><br>Nero Raggrinzato<br>Wrinkled Black                                   | <b>97RG</b><br>Grigio Raggrinzato<br>Wrinkled Grey                                  | <b>CROMO</b><br>Lucido<br>Chromium-plated<br>(solo per ringhiera)<br>(only for banister) | <b>RAL 7015</b><br>Grigio<br>Grey   |
| <b>Diable/Akura/Pura/Chrome</b>   |   |   |   | X  |   |
| <b>Ghibli/Esperia/Fly/Vertico</b> | X   | X   | X   | X  | •   |
| <b>Jazz/Jazz Chrome/CZ</b>        | X   | X   | X   | X  | •   |
| <b>Econ/Star</b>                  | X   | X   | X   |  |   |
| <b>Vip/Fox/Silver/FX/Dixi</b>     | X   | X   | X   |  |   |
| <b>Scaligera/Viscontea/Viscal</b> |   | X   |   |  |   |
| <b>Gamma/Ghibli</b>               | X   | X   | X   | X  |   |
| <b>Nika/Nika Chrome</b>           | X   | X   | X   | X  | X   |
| <b>Nuvola</b>                     |   |   | X   | X  |   |
| <b>Mignon/Marinara</b>            | X   | X   | X   |  | •   |

|  |
|--|
|  |
| <b>GOLD</b>  |
| <b>Mantis</b>  |
| X  |

Mantis

X

|                               |  |  |  |  |  |
|-------------------------------|---|---|---|---|---|
|                               | <b>RAL 5002</b><br>Blu<br>Blue  | <b>RAL 6026</b><br>Verde<br>Green   | <b>RAL 3000</b><br>Rosso<br>Red   | <b>RAL 1021</b><br>Giallo<br>Yellow   | <b>RAL 3005</b><br>Bordeaux<br>Bordeaux   |
| <b>Ghibli</b>                 | •   | •   |   |   |   |
| <b>Star</b>                   | •   | •   | •   | •   | •   |
| <b>Esperia/Vertigo/Fly/CZ</b> | •   | •   | •   | •   | •   |
| <b>Mignon/Marinara</b>        | •   | •   | •   | •   | •   |
| <b>Nika/Nika Chrome/Econ</b>  | X   | X   | X   | X   | X   |

I toni dei colori sono da intendersi indicativi e possono verificarsi piccole variazioni. The colors tones are to be considered as indicative and they could vary slightly.

step1



step2

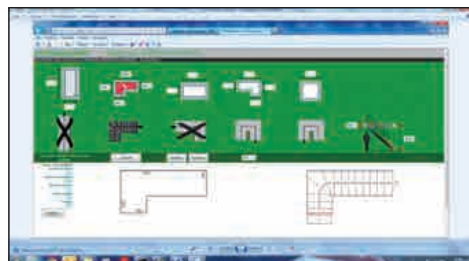

Scopri subito i vantaggi del sito web Mobirolo, perché ora puoi finalmente progettare la tua scala con l'eccezionale configuratore, il software che permette di scegliere in modo semplice ed intuitivo il modello che più desideri, adattandolo al tuo ambiente.

Discover now the advantages of the Mobirolo Website: you can project your stair with the exceptional configurator; easily you will select the model you desire, adapting it to your living spaces.

Ogni riproduzione totale o parziale dei contenuti, sia di testo che di immagine, del presente catalogo è vietata e sarà perseguita a termini di legge. © 2010 Mobirolo S.p.A.: tutti i diritti riservati.

Total or partial reproduction of text or illustrations of this catalogue is prohibited and is subject to legal sanctions. © 2010 Mobirolo S.p.A.: all rights reserved.

I dati contenuti in questo catalogo sono forniti a titolo indicativo. Mobirolo si riserva il diritto di apportare modifiche ai modelli in qualunque momento per ragioni di natura tecnica o commerciale.

The information provided in this catalogue is of an indicative nature. Mobirolo reserves the right to make changes at any time to its models for technical or commercial reasons.

50°  
mobirolo  
1966  
2016



[www.mobirolo.com](http://www.mobirolo.com)



**Mobirolo S.p.A.**  
Strada C. Colombo, 22/a 42046 Reggiolo (RE) Italy  
Tel 0522.211811 Fax 0522.973139  
[mobirolo@mobirolo.it](mailto:mobirolo@mobirolo.it) P.IVA 02620340352  
Export Department: Tel. +39 0522 211812 Fax +39 0522 973217  
[export2@mobirolo.it](mailto:export2@mobirolo.it)



RICHIEDI I PRODOTTI CERTIFICATI FSC®



ORGANISMO ACCREDITATO DA ACCREDIA  
NON ACCREDITED BY ACCREDIA

TOTAL  
PRODUCTION



MADE IN ITALY

I/GB

Cod. 10.1\_08.2017