

 Scala a chiocciola da esterno disponibile con forma tonda;
Gradini in metallo zincati a caldo per la versione Econ Z o con zincatura galvanica+verniciatura epossidica per la versione Econ Zincolor;
Palo centrale in metallo;
Ringhiera con colonne in acciaio inox;
Corrimano e pedane disponibili solo in PVC grigio.

 Spiral staircase for outdoor use available with round shape;
Metal hot galvanized steps for ECON Z version or galvanized +epoxy painting for ECON ZINCOLOR version;
Metal central pole;
Banister with stainless spindles;
PVC handrail and step covers available in GREY color only.

 Escalier en colimaçon pour usage extérieur disponible dans la forme ronde;
Marches en métal avec traitement galvanisé à chaud dans la Version ECON Z ou avec galvanisation+ époxy vernissage dans la version ECON ZINCOLOR;
Poteau central en métal ;
Garde-corps avec colonnes en acier inoxydable ;
Main courante et couvre-marches disponibles en PVC gris seulement.

 Spindeltreppe mit rundem Form erhältlich für den Außeneinsatz
Stufen aus Metall feuerverzinkt für Modell ECON Z oder Verzinkung + Epoxidbeschichtung für Modell ECON ZINCOLOR ;
Zentrale Metallstange;
Geländer mit Edelstahlsäulen
Handlauf und Stufenabdeckungen nur in GRAUEM PVC erhältlich .

 Escalera de caracol disponible en forma redonda para exteriores;
Escalones en metal galvanizada en caliente para la versión ECON Z o con revestimiento galvánico + epoxi para la versión ECON ZINCOLOR;
Poste central de metal;
Barandilla con columnas de acero inoxidable;
Pasamanos y cubre peldaño sólo disponible en PVC GRIS.

Dettagli tecnici

Technical details - Détails techniques
Technische Details - Ficha técnica

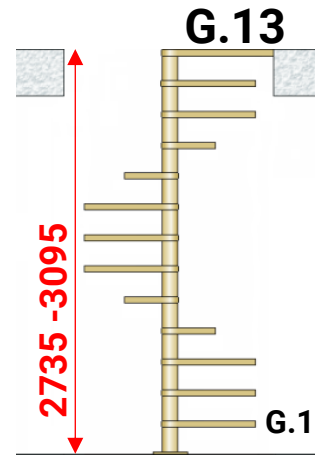
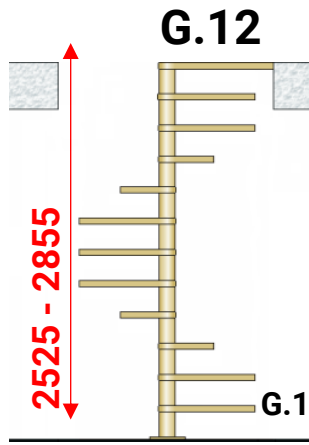
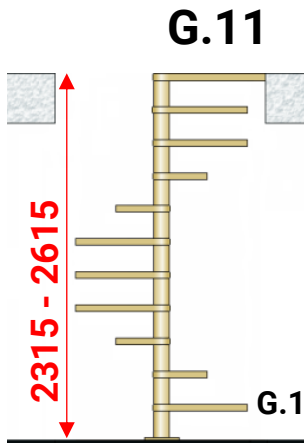

IMBALLO
Dim. 115x97x74 cm
Peso: circa 190/250 kg.

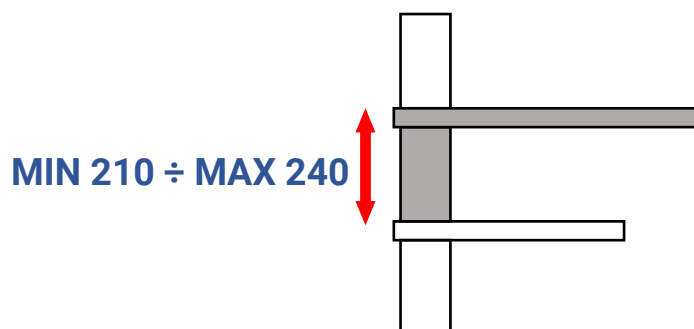
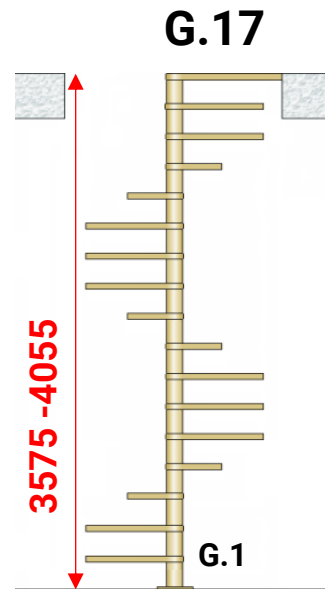
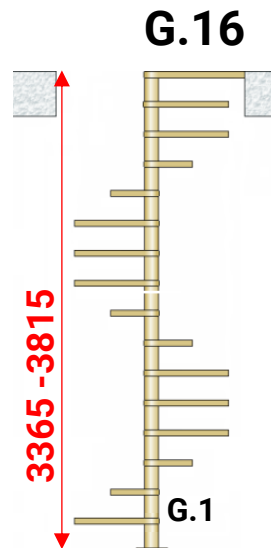
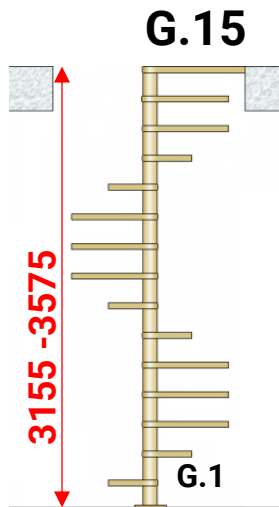
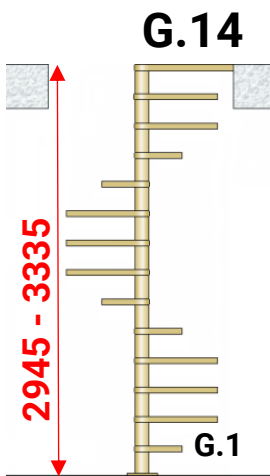

Dettagli tecnici

Technical details - Détails techniques

Technische Details - Ficha técnica

L	C1	C2	C3	P.U.	P.M.
Ø1000	532	609	520	399	129,7
Ø1100	578	660	570	449	142,6
Ø1200	624	711	620	499	155,6
Ø1400	716	813	720	599	163,6
Ø1600	808	915	820	699	187,0

FORO, WELL, TRÊMIE, LOCH, HUECO

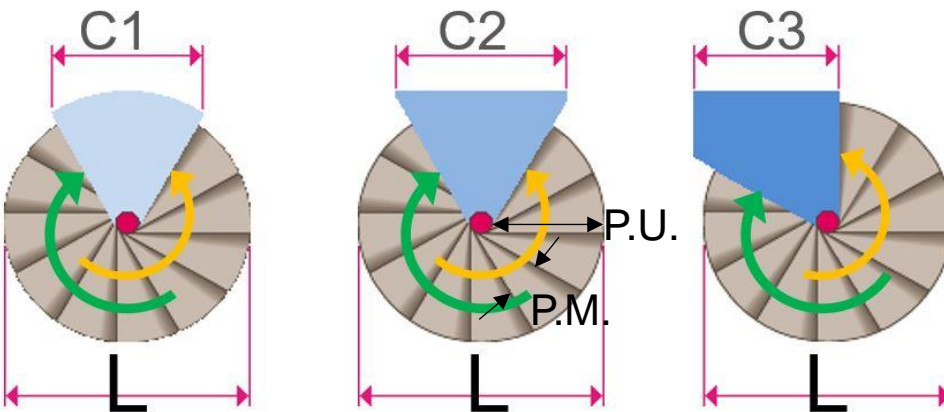
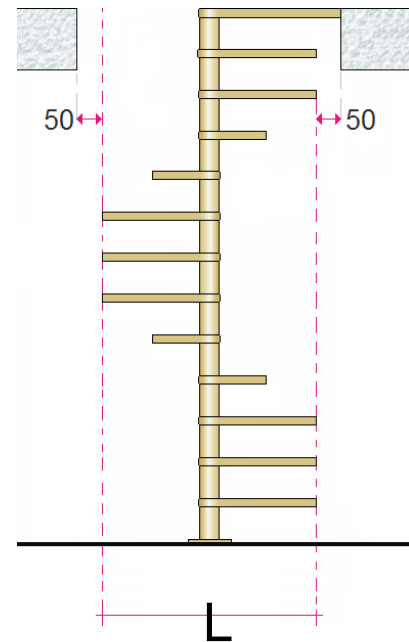

FISSAGGIO ARRIVO SBARCO, FIXING OF THE ARRIVAL LANDING, FIXATION DU PALIER D'ARRIVÉE, BEFESTIGUNG DES ANKUNFTSPODESTS

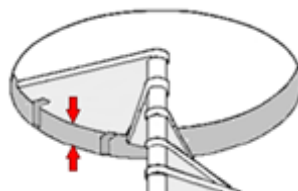

MIN 210

APERTURA GRADINI, TREADS OPENING, OUVERTURE DES MARCHES, ÖFFNUNG DER STUFEN, APERTURA DE LOS ESCALONES

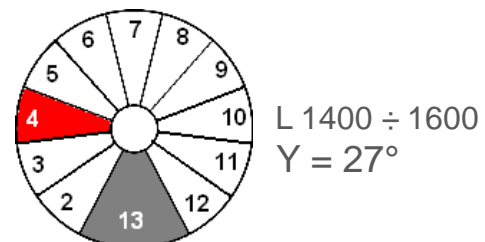
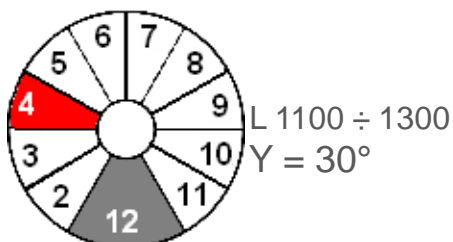

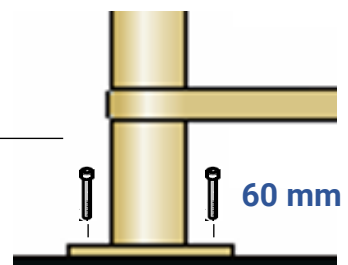

Ø45 PVC grigio
grey PVC
gris PVC
graus PVC
PVC gris



Ø 22 mm

**Zincatura galvanica+
verniciatura epossidica**

Galvanized+epoxy painting

**Placage galvanique+
Peinture époxy**

**Galvanische Beschichtung+
Epoxid-Lackierung**

**Galvanicado+
Pintura epoxi**

200 Kg/m² 

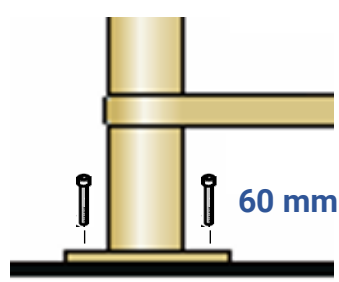

60 mm

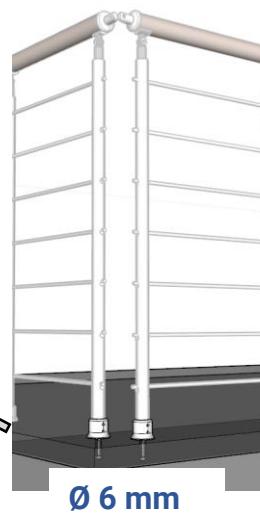
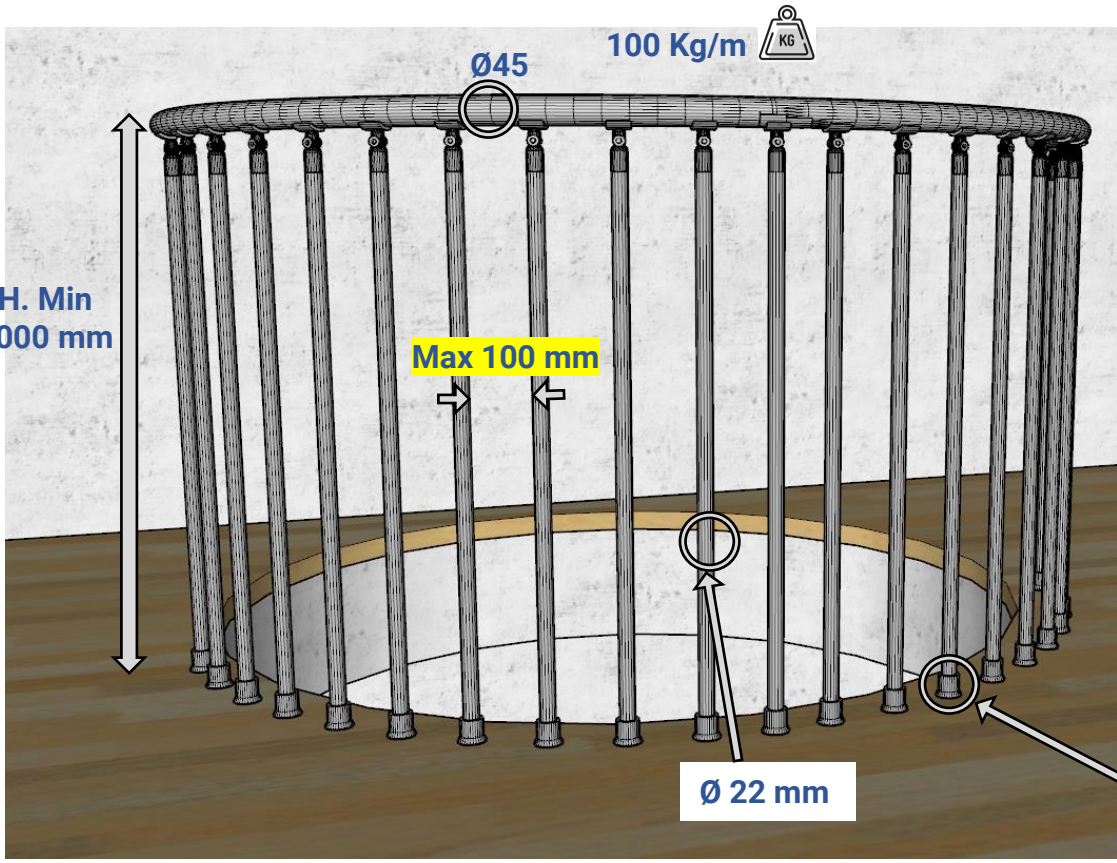
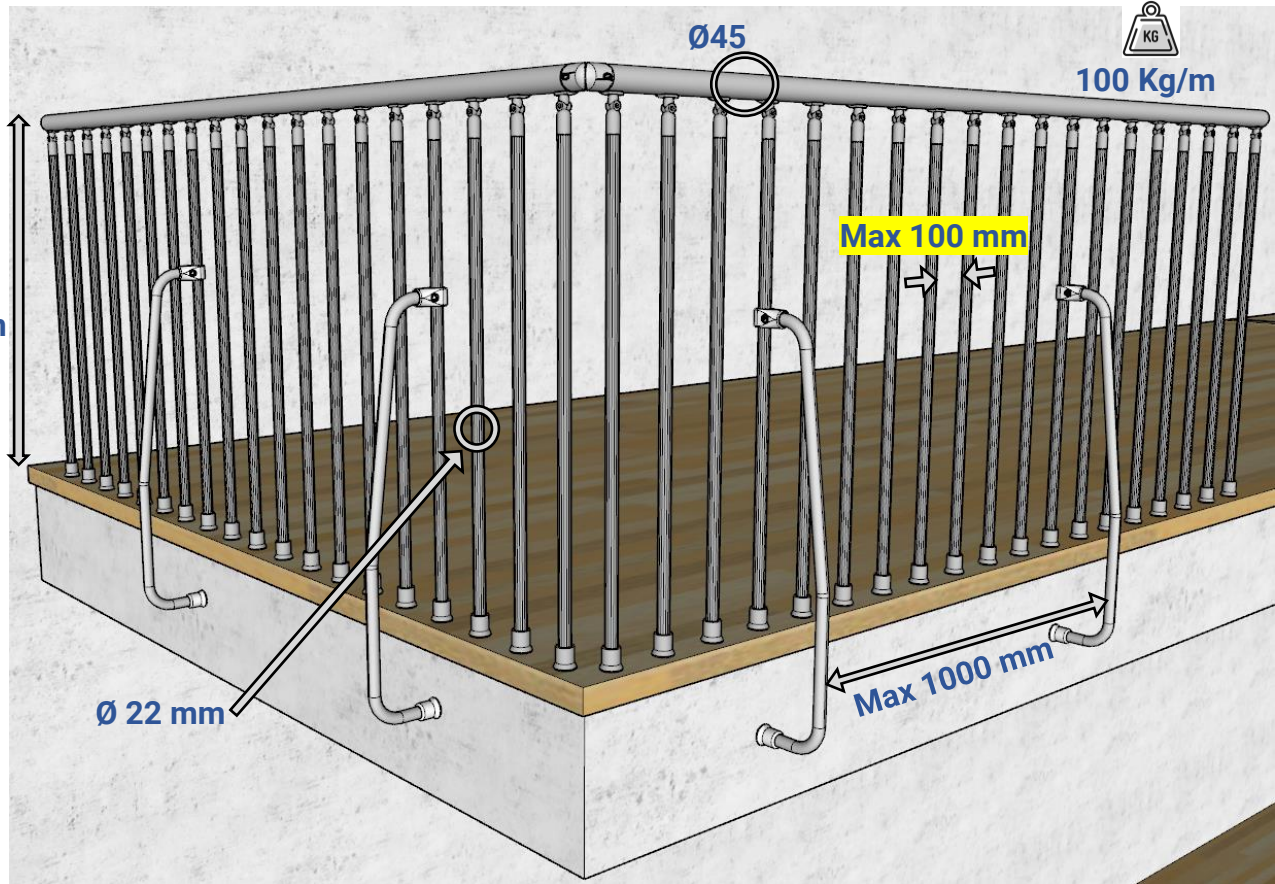

Sbarco su misura
Landing on measure - Palier sur mesure
Podest nach Maß - Desembarque personalizado

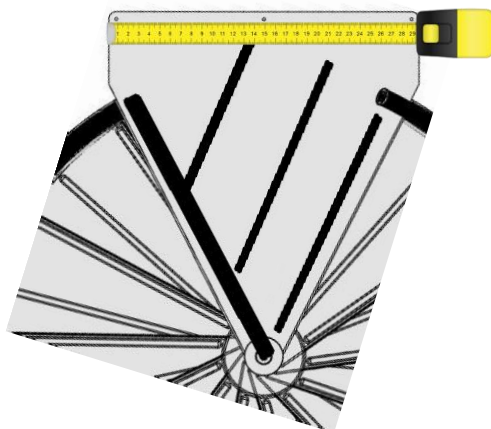

Scala sovrapposta
Overlapping staircase - Escalier superposé,
überlagerte Treppe - Escalera superpuesta

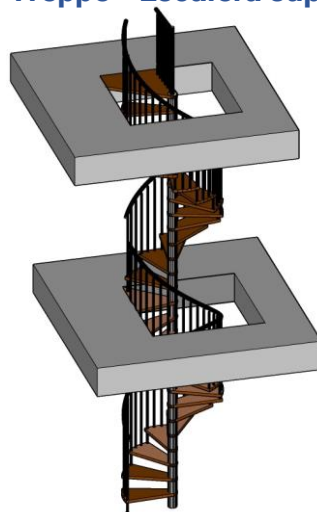

Pianerottolo tondo
Round landing - Palier ronde
Runde Podest - Desembarco redondo

