

DIXI

FORME

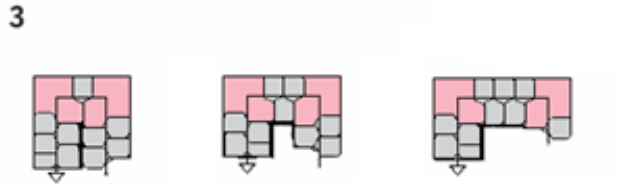

| G10 | G11 | G12 | G13 |
|------|------|------|------|
| h | h | h | h |
| 2111 | 2301 | 2491 | 2681 |
| 2561 | 2796 | 3031 | 3266 |



ALZATA E PEDATA

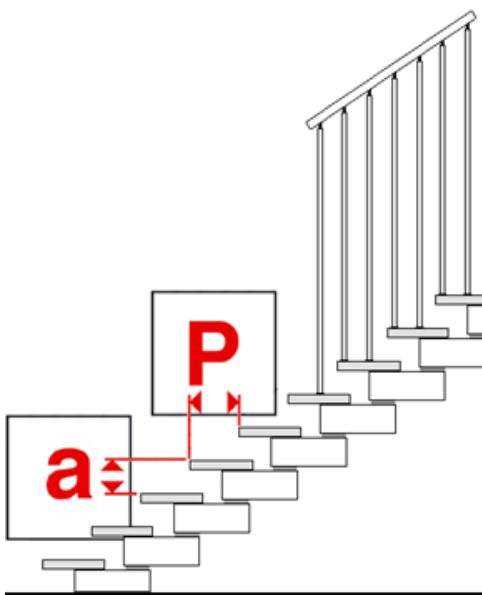

a = 190 min
a = 235 max

P = 120 std

DIXI

CARATTERISTICHE

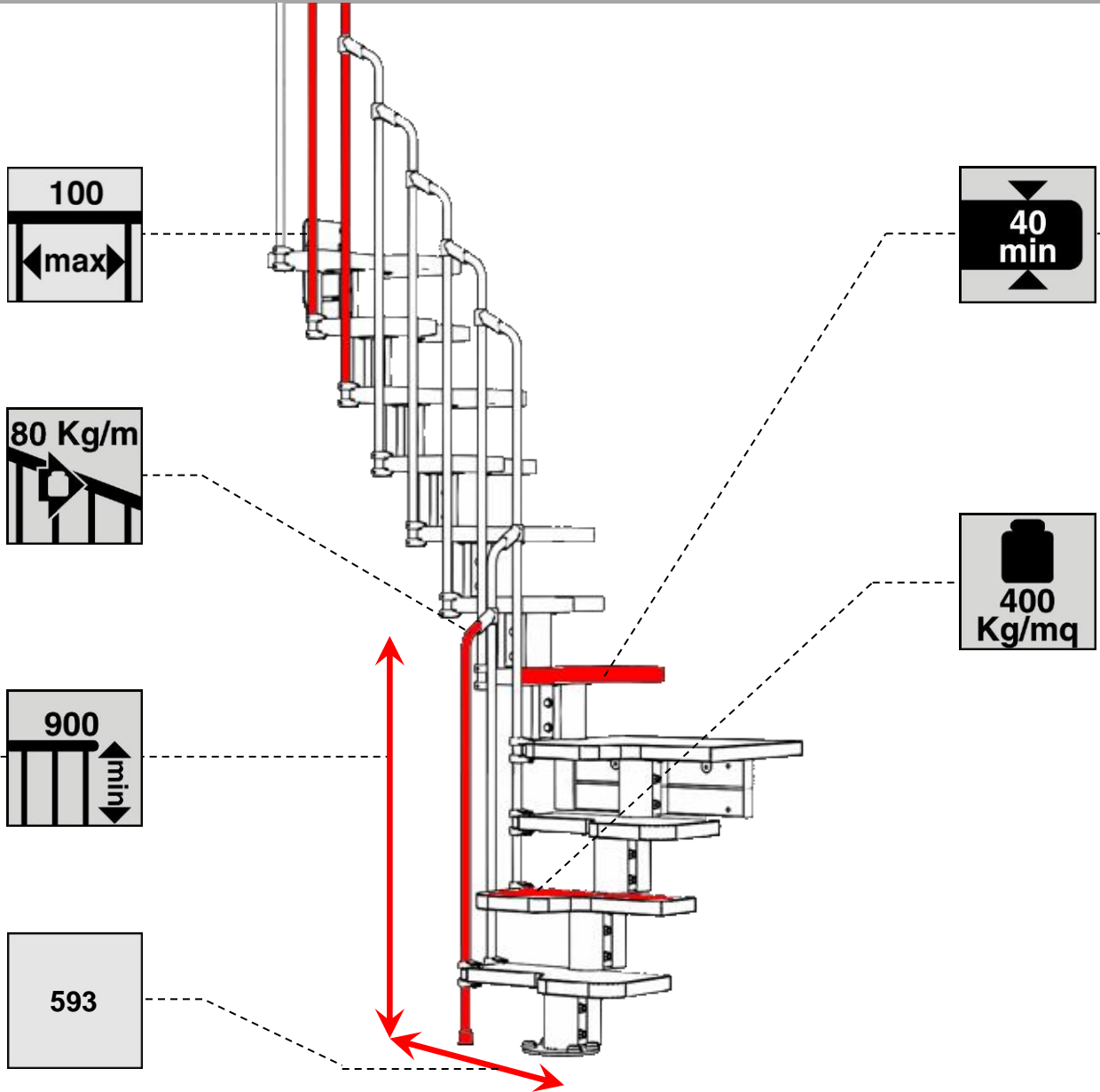

DIXI

ARRIVO E PARTENZA

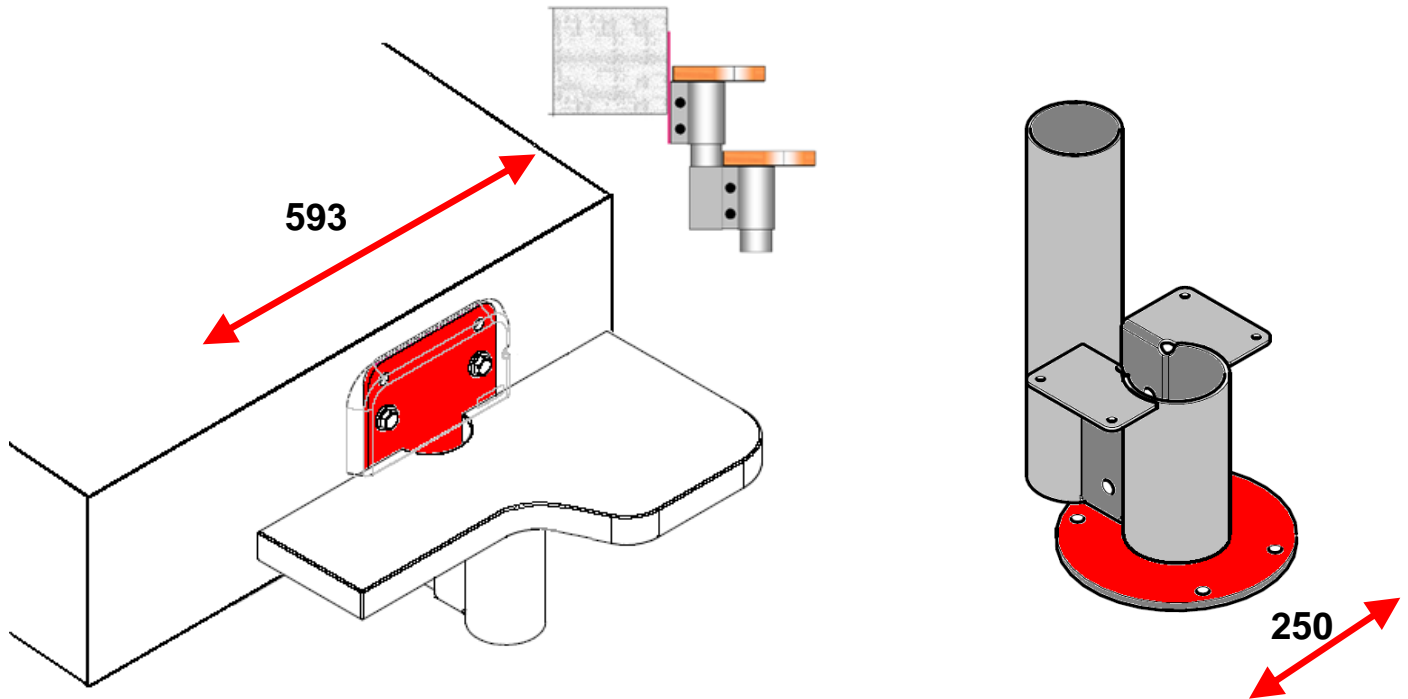

BALAUSTRÉ

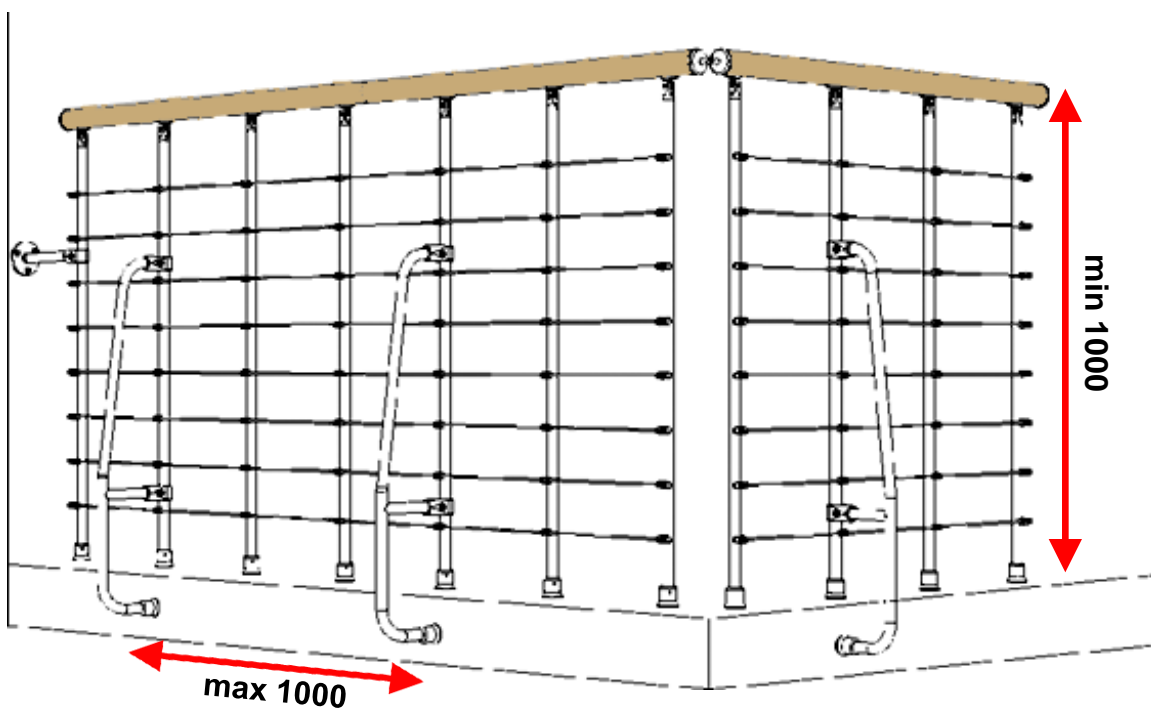

DIXI

COLORS - Faggio, Beech, Hêtre, Buche, Haya



252
Noce medio
Light chestnut
Nussbaumholz
Noyer moyen
Nogal medio

253
Naturale
Natural
Naturbuchenholz
Couleur naturelle
Natural

258
Rovere
Oak
Eichenholz
Couleur rouvre
Roble

287
Ciliegio
Cherry stain
Kirschholz
Couleur cerisier
Color cerezo



289
Doussié
Doussié
Doussié
Doussié
Doussié

311
Sbiancato
Whitened wood
Bleichesholz
Blanchi
Madera blanqueada

312
Wenghè
Wenghè
Wenghè
Wenghè
Wenghè

400
Grigio
Grey
Grau
Gris
Gris

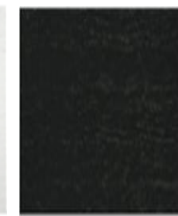
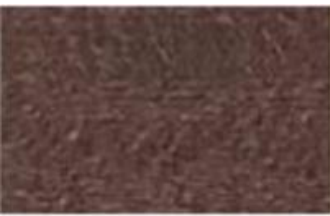

410
Cacao
Cacao
Kakao
Cacao
Cacao

420
Sabbia
Sand
Sandfarben
Sable
Arena

430
Tortora
Dove grey
Taubengrau
Gris tourterelle
Gris ceniciento

305S
Bianco
White
Weiß
Blanc
Blanco

390S
Nero
Black
Schwarz.
Noir
Negro



401DEC
Grigio
Grey
Grau
Gris
Gris

411DEC
Cacao
Cacao
Kakao
Cacao
Cacao

421DEC
Sabbia
Sand
Sandfarben
Sable
Arena

431DEC
Tortora
Dove grey
Taubengrau
Gris tourterelle
Gris ceniciento

DIXI

COLORS – trattamenti del legno



OPTIONAL

Trattamento spazzolato
Brushed treatment,
Traitement brossé,
Gebürstetes Behandlung,
tratamiento cepillado



OPTIONAL

Tinta a campione,
Sample color,
Tinte à échantillon,
Farbe nach Muster,
Muestra de color

COLORS METAL

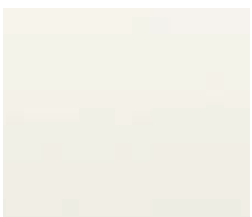

RAL 9001
Bianco
White
Blanc
Weiss
Blanco



95 RG
Nero raggrinzato
Wrinkled Black
Noir granité
Schwarz runzlig
Negro arrugado



97 RG
Grigio raggrinzato
Wrinkled Grey
Gris granité
Grau runzlig
Gris arrugado