

Forme · Formes · Shapes · Formen · Formas

1

2 **Realizzabile solo - disponible seulement available only - Verfüegbar nur realizable solo**
Jazz 25

3 **Realizzabile solo - disponible seulement available only - Verfüegbar nur realizable solo**
Jazz 25

3S **Solo - Seulement Only - Nur - Solo**
Jazz 22 850
Jazz 25 950 **Realizzabile solo - disponible seulement available only - Verfüegbar nur realizable solo**
Jazz 25

4

	G10	G11	G12	G13	G14	G15	G16	G17
h	h	h	h	h	h	h	h	h
	1925	2100	2275	2450	2625	2800	2975	3150
	2325	2540	2755	2970	3185	3400	3615	3830



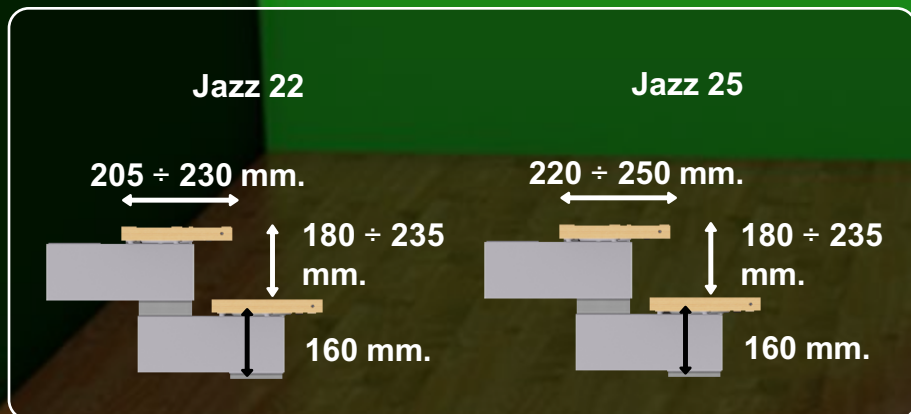
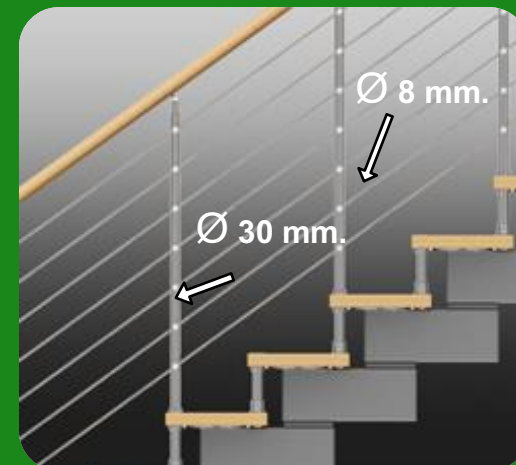
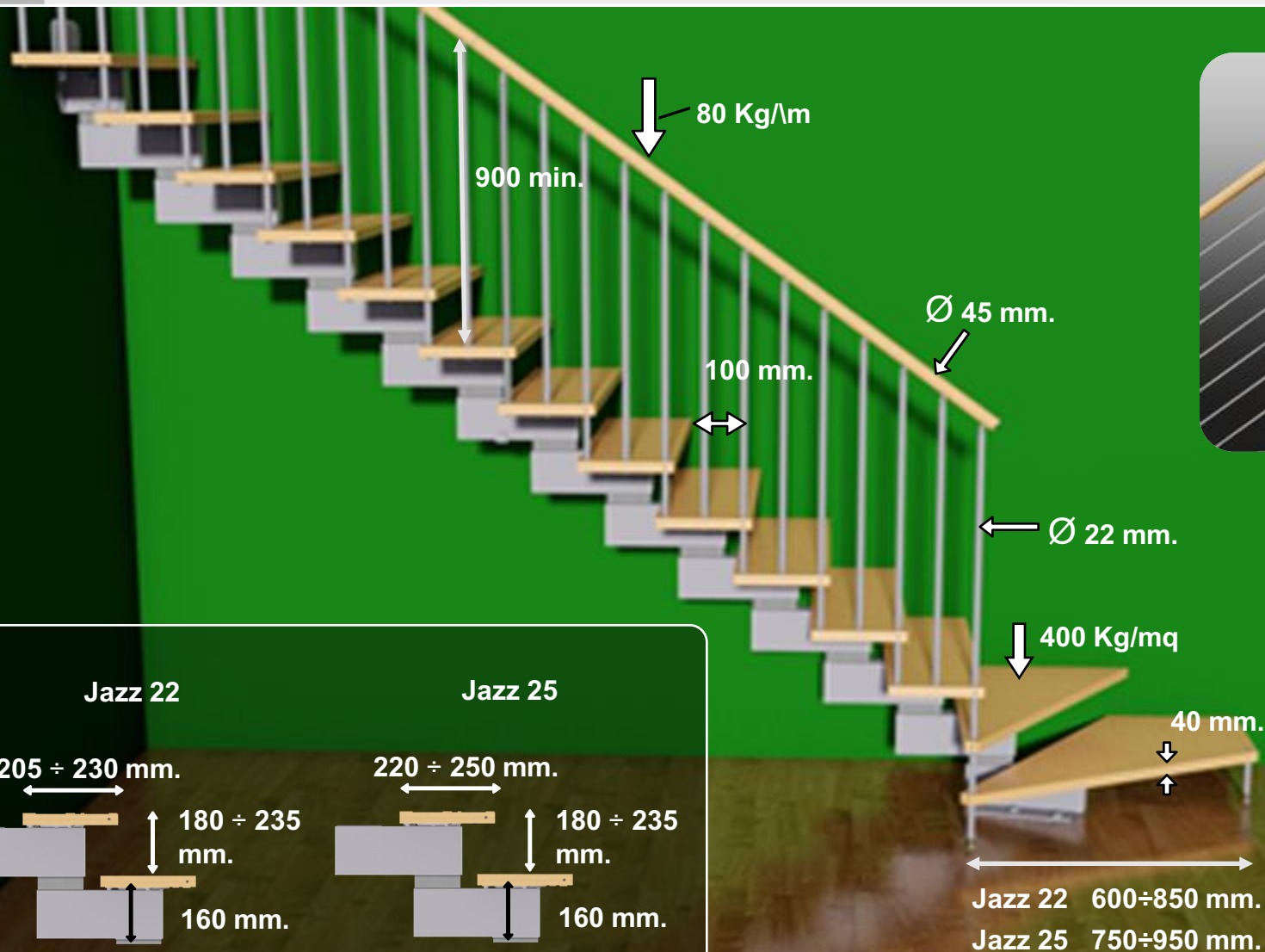

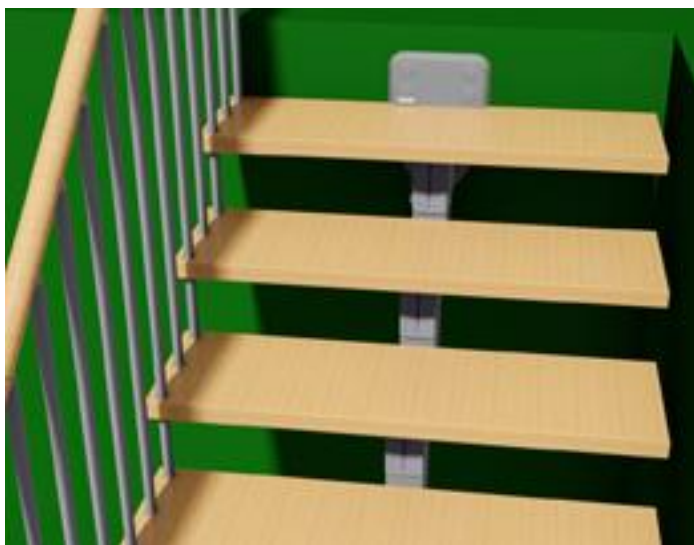
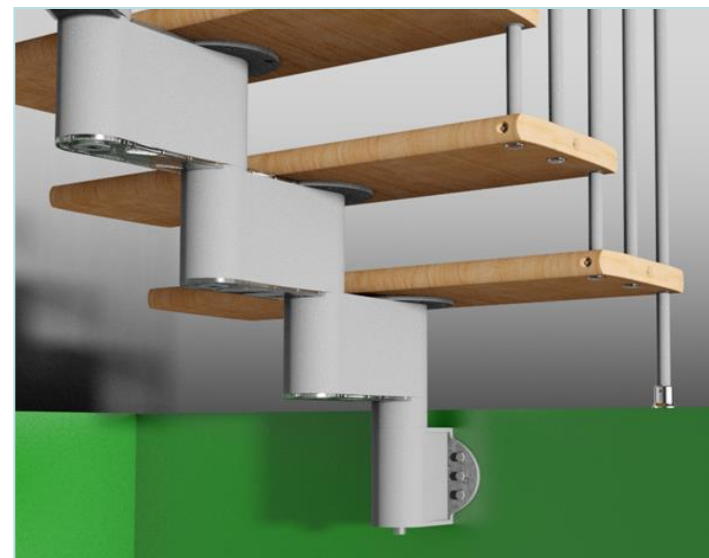

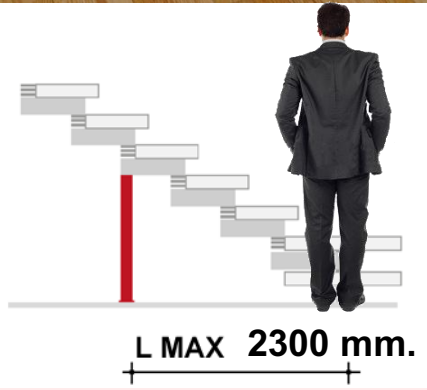
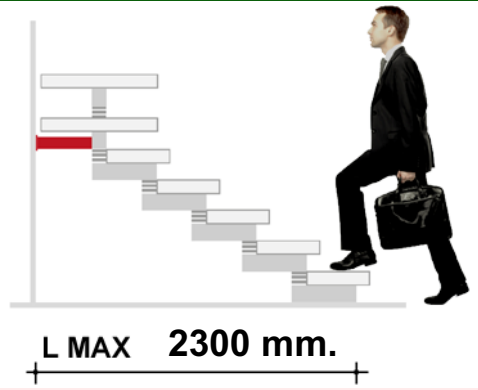
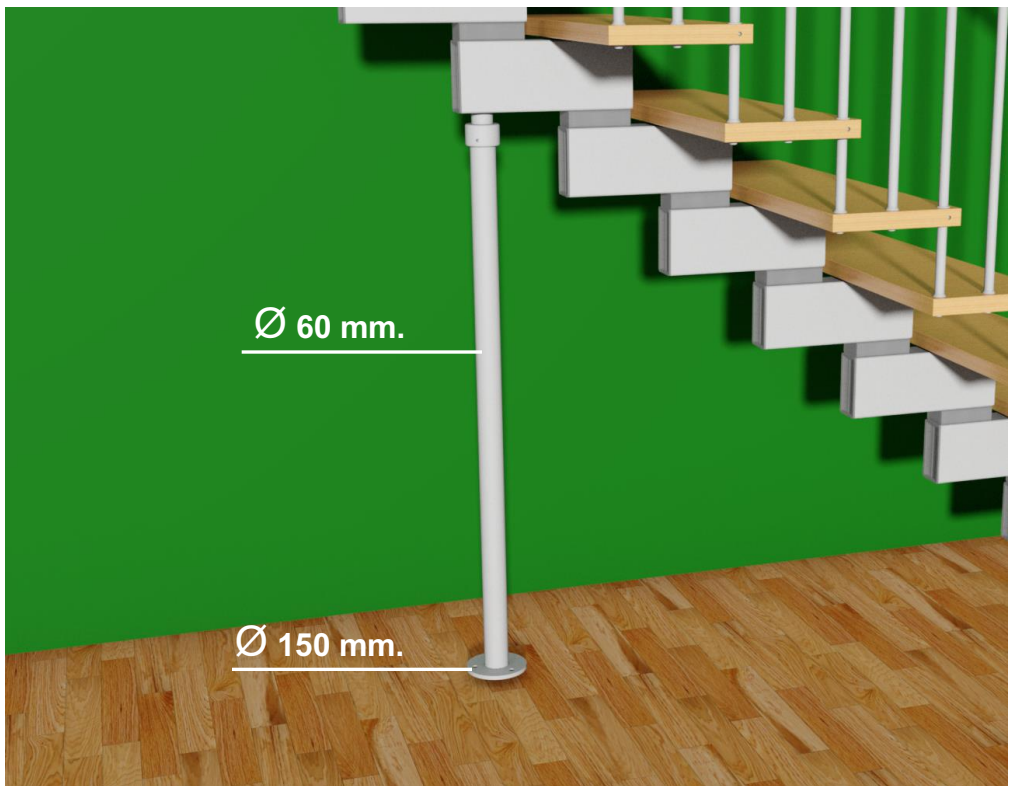
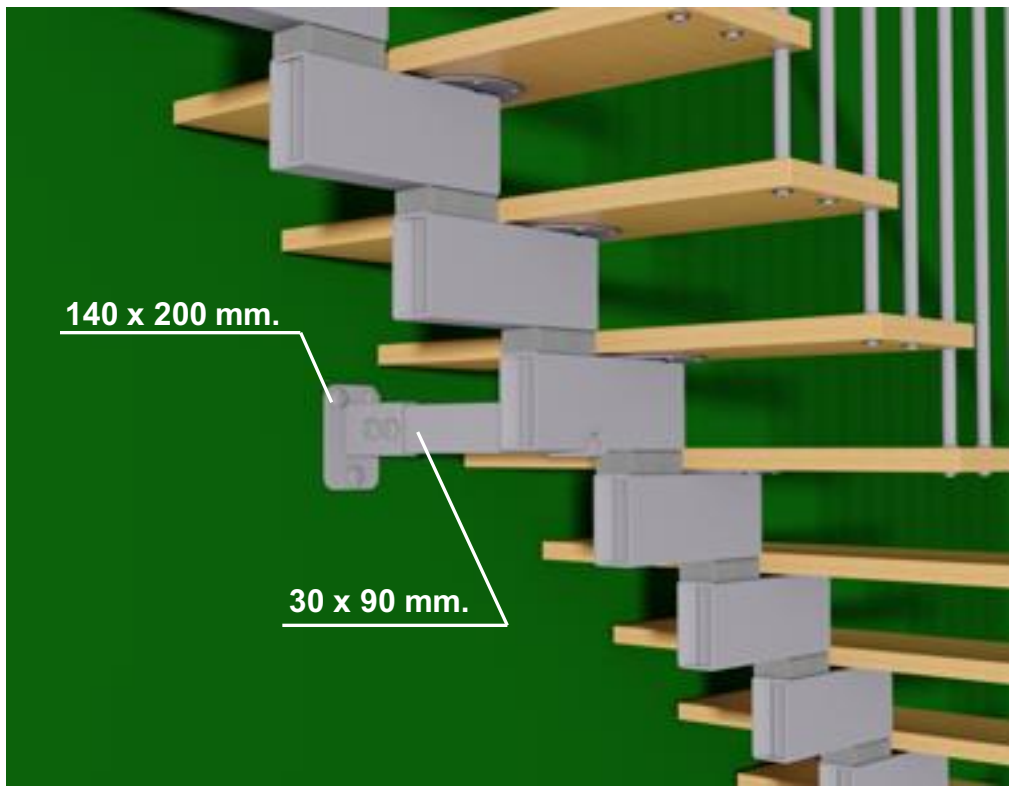

SC

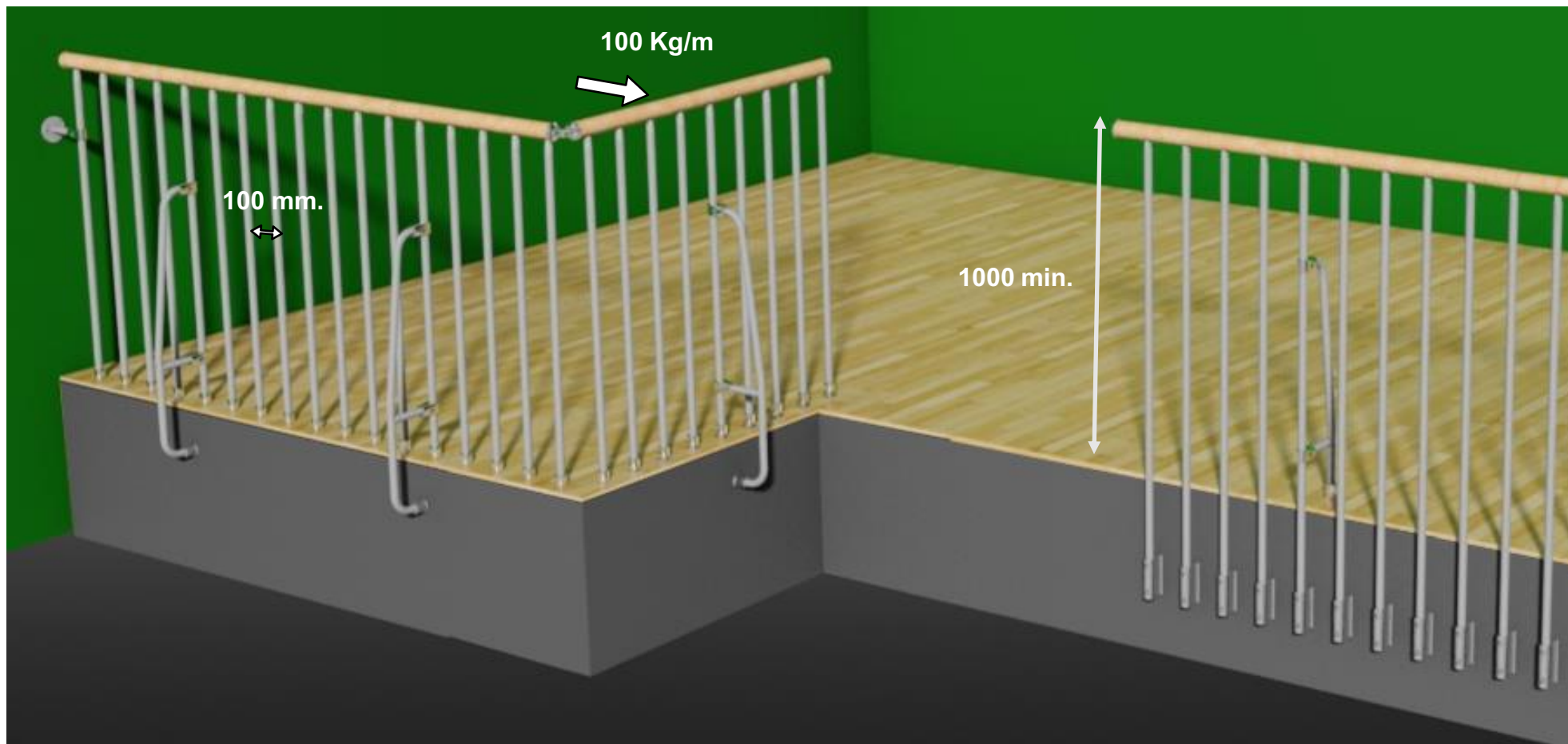

CHROME

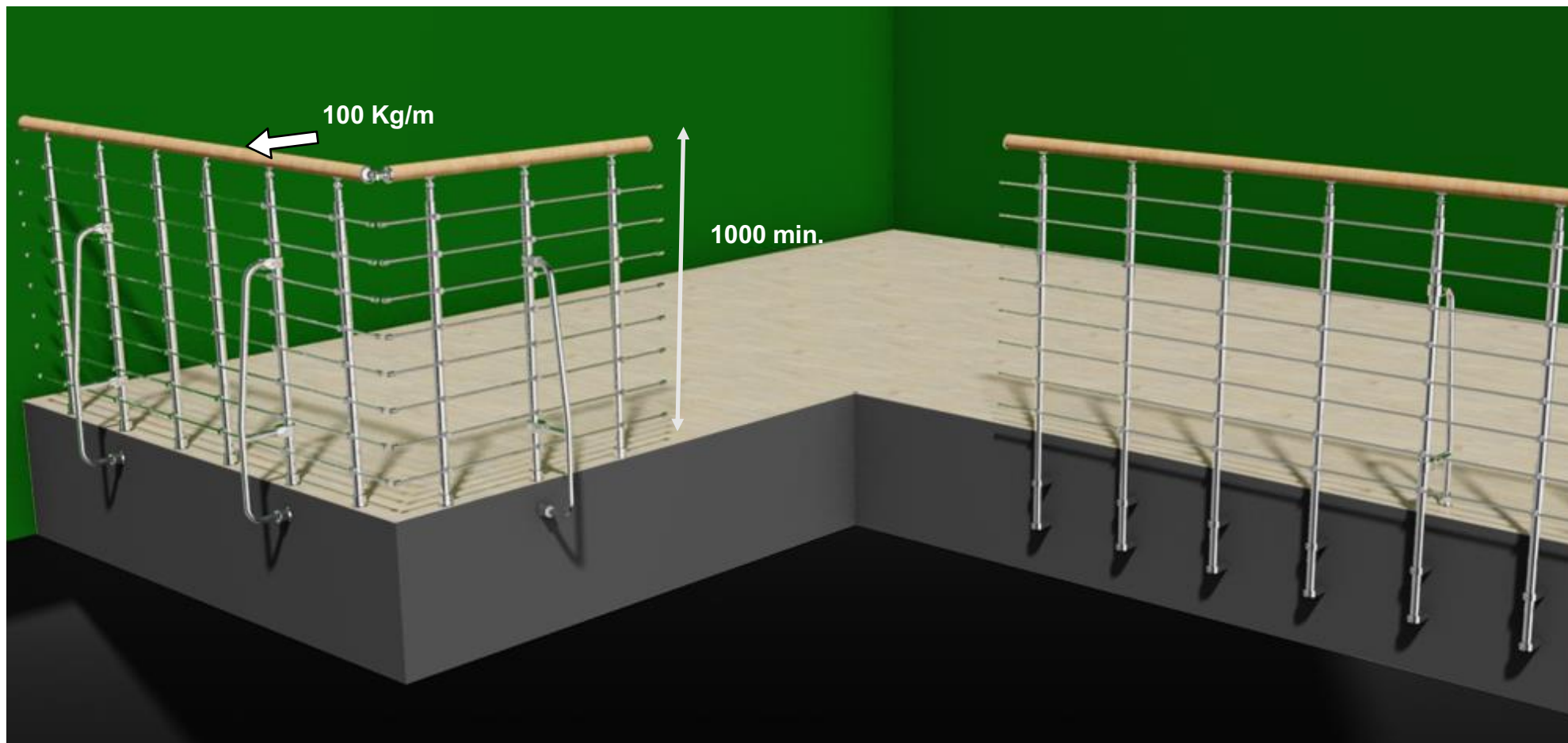

OPTIONAL

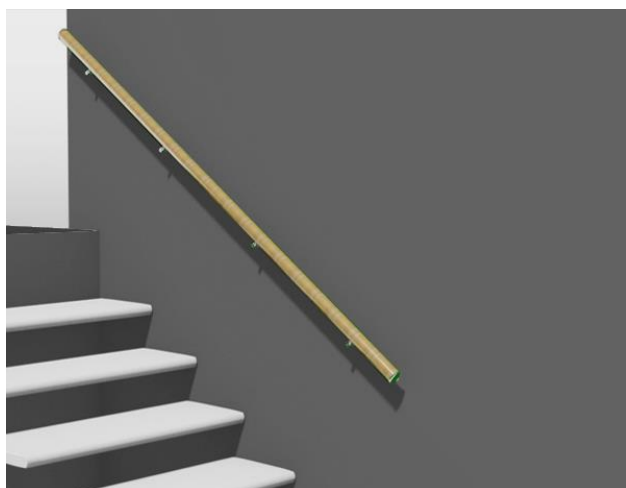
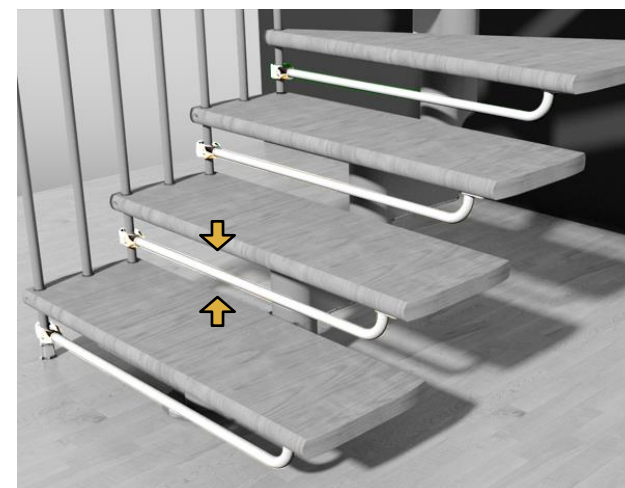
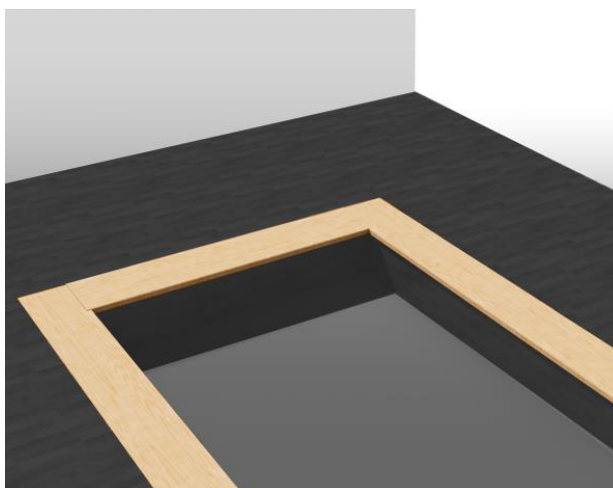

COLORS - Faggio, Beech, Hêtre, Buche, Haya

									
252 Noce medio Beech/light chestnut. Buche/Nussbaumholz.	253 Naturale Beech/natural. Buche/Naturbuchenholz.	258 Rovere Beech/oak. Buche/Eichenholz.	287 Ciliegio Beech/cherry stain. Buche/Kirschholz.	289 Doussié Beech/doussié. Buche/Doussié.	311 Sbiancato Fir/whitened wood. Fichte/Bleichholz.	312 Wenghè Fir/wenghè. Fichte/Wenghè.	400 Grigio Fir/grey. Fichte/grau.	410 Cacao Cacao. Kakao.	420 Sabbia Sand. Sandfarben.
									
430 Tortora Dove grey. Taubengrau.	401 DEC Grigio Beech/grey. Buche/grau.	411 DEC Cacao Cacao. Kakao.	421 DEC Sabbia Sand. Sandfarben.	431 DEC Tortora Dove grey. Taubengrau.					

METAL COLORS

		
90 RG Bianco White Weiss Blanc Blanco	95 RG Raggrinzato Wrinkled black Schwarz runzlig Noir granité Negro arrugado	97 RG Grigio raggrinzato Wrinkled Grey Grau runzlig Gris granité Gris arrugado