

Realizzabile solo - disponible seulement - available only - Verfuegbar nur - realizable solo

750 mm + 1000mm

1000 mm

750 mm + 1000mm

	G10	G11	G12	G13	G14	G15	G16	G17
h	h	h	h	h	h	h	h	h
	1925	2100	2275	2450	2625	2800	2975	3150
	2325	2540	2755	2970	3185	3400	3615	3830



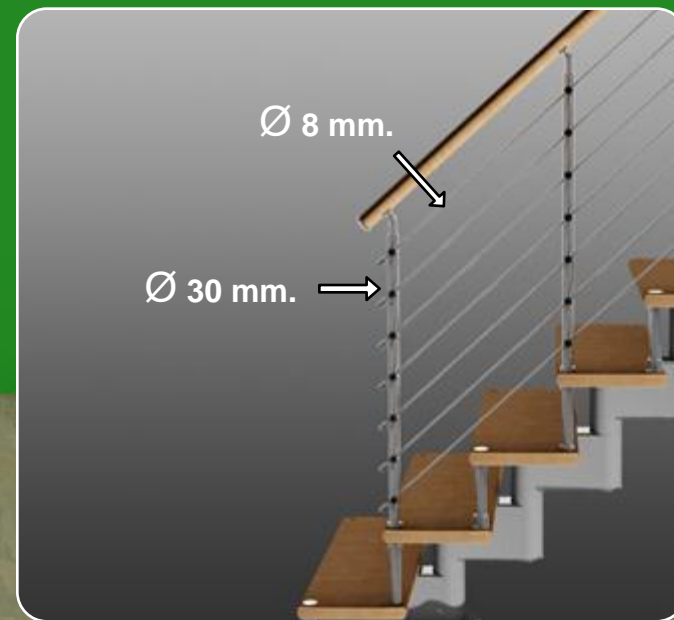
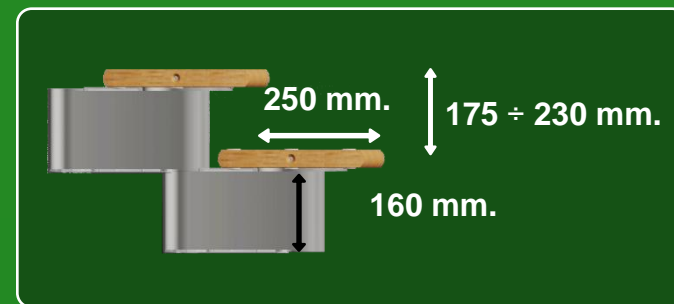

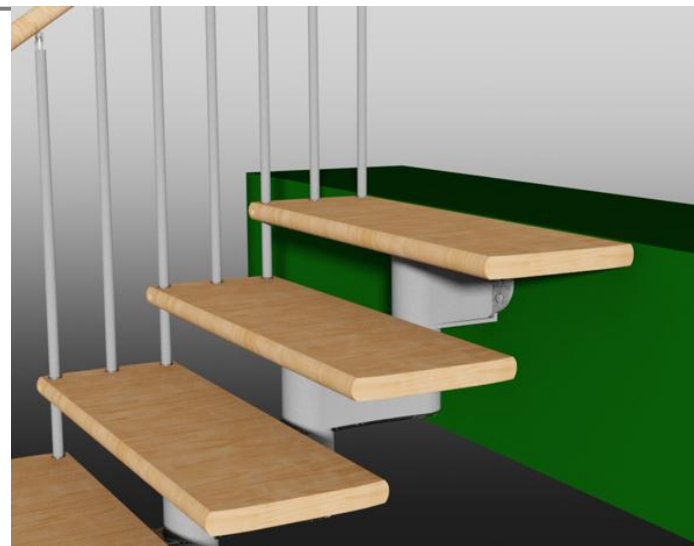
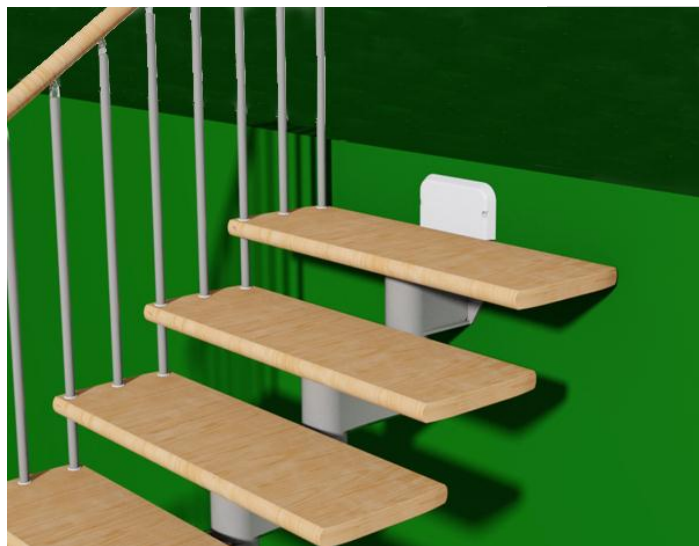
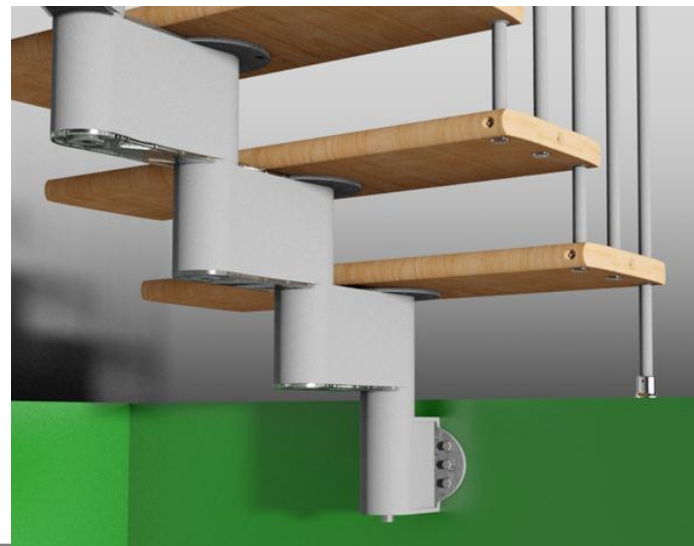
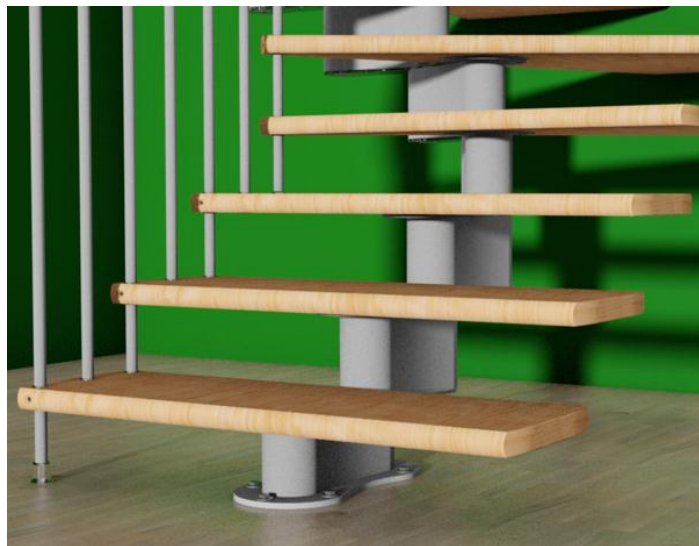

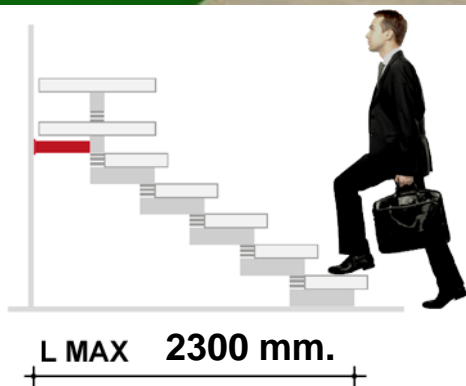
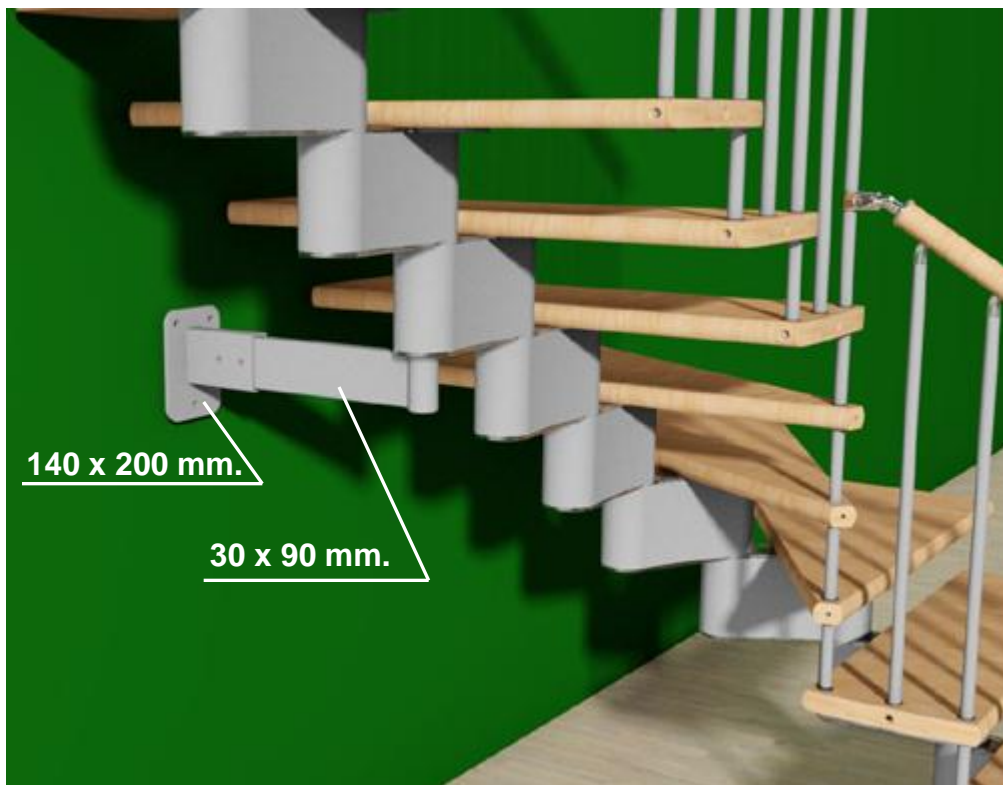

SC

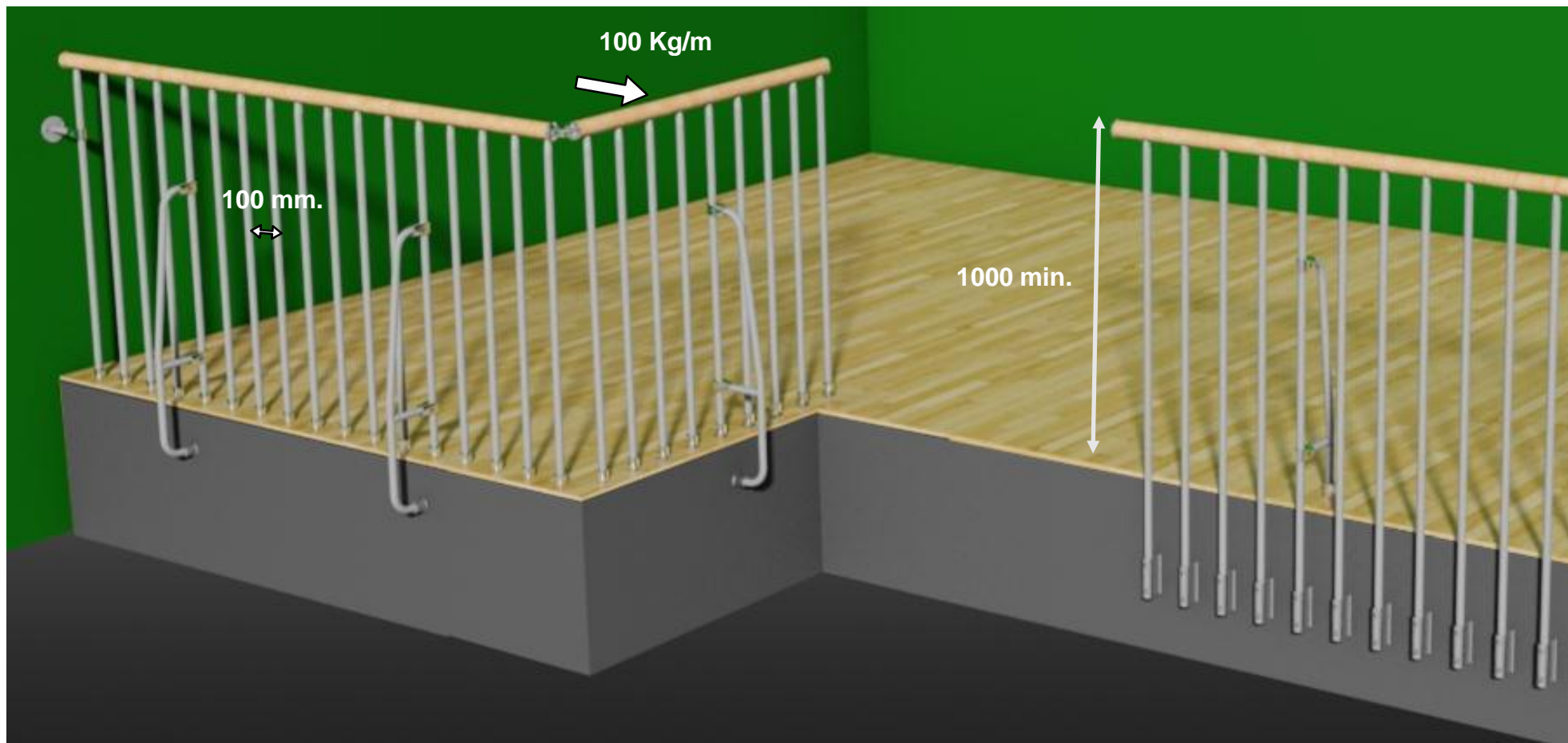

CHROME

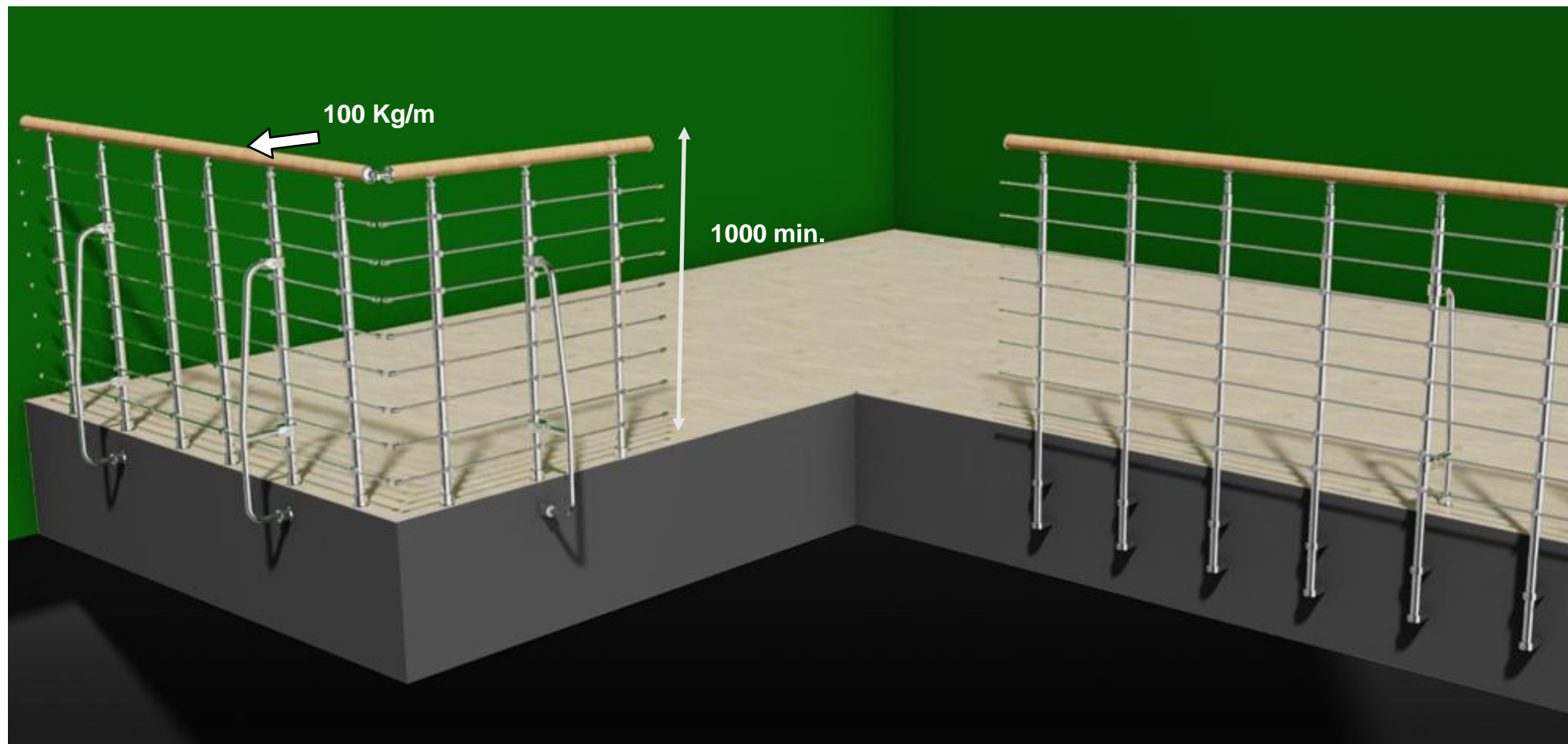

OPTIONAL

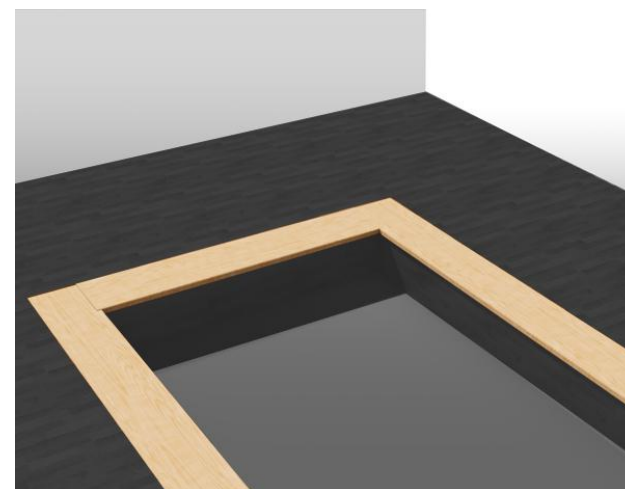
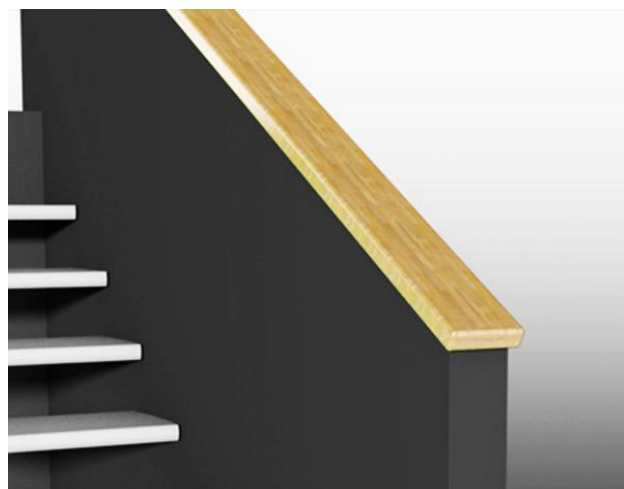
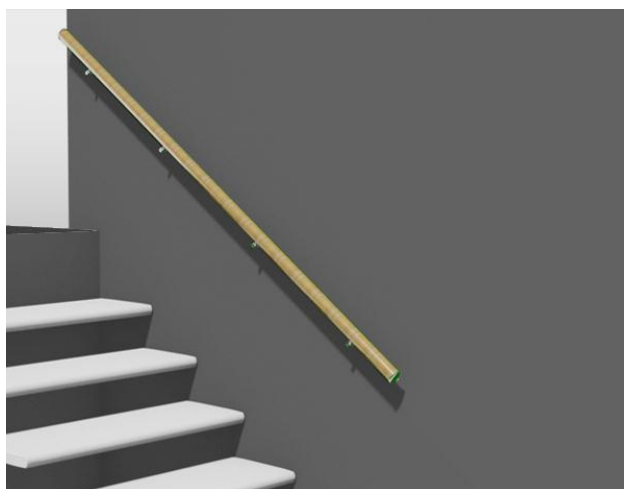
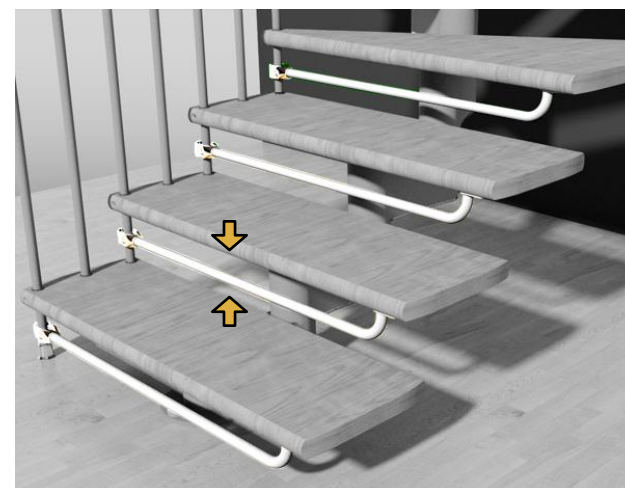

COLORS - Faggio, Beech, Hêtre, Buche, Haya

METAL COLORS

252 Noce medio Light chestnut Nussbaumholz Noyer moyen. Nogal medio.	253 Naturale Natural Naturbuchenholz Couleur naturelle Natural	258 Rovere Oak Eichenholz Couleur rouvre Roble	287 Ciliegio Cherry stain Kirschholz Couleur cerisier Color cerezo	289 Doussié Doussié Doussié Doussié Doussié
311 Sbiancato Whitened wood. Bleichesholz. Blanchi. Madera blanqueada	312 Wenghè Wenghè Wenghè Wenghè Wenghè	400 Grigio Grey Gru Gris Gris	410 Cacao Cacao Kakao Cacao Cacao	420 Sabbia Sand Sandfarben Sable Arena
430 Tortora Dove grey Taubengrau Gris tourterelle Gris ceniciento	401 DEC Grigio Grey Gru Gris Gris	411 DEC Cacao Cacao Kakao Cacao Cacao	421 DEC Sabbia Sand Taubengrau Sable Arena	431 DEC Tortora Dove grey Taubengrau Gris tourterelle Gris ceniciento

RAL 9001 Bianco White Weiss Blanc Blanco	95 RG Raggrinzato Wrinkled black Schwarz runzlig Noir granité Negro arrugado	97 RG Grigio raggrinzato Wrinkled Grey Gru runzlig Gris granité Gris arrugado	RAL 9007 Grigio metallizzato Metal grey Aluminium Grau Gris aluminium Gris aluminio	RAL 5002 Blu Blue Blau Bleu Azul
RAL 6026 Verde Green Gru Vert Verde	RAL 3000 Rosso Red Rot Rouge Rojo	RAL 1021 Giallo Yellow Gelb Jaune Amarillo	RAL 2011 Arancio Orange Orange Orange Naranja	RAL 4002 Viola Violet Violett Violet Violeta
RAL 3005 Bordeaux Bordeaux Bordeaux Bordeaux Bordeaux Burdeous	RAL 7021 Grigio scuro Dark grey Dunkel Grau Gris foncé Gris oscuro	Cromo Lucido (solo per ringhiera) Chromium-plated (only for banister) Verchromt (nur für Geländer) Chromé (seulement pour Garde-Corps escalier) Cromado (solo per barandilla)		