

ECON

DIAMETRI E PIANEROTTOLI, DIAMETERS AND LANDINGS, DIAMÈTRES ET PALIERS

FORO, WELL, TRÉMIE

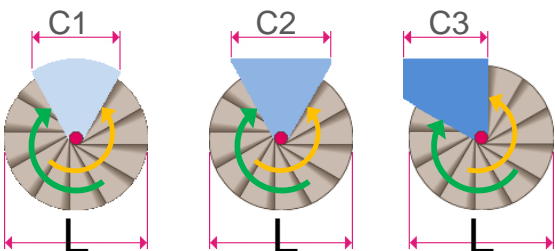

L	C1	C2	C3
1000	532	609	520
1100	578	660	570
1200	624	711	620
1400	716	813	720
1600	808	915	820

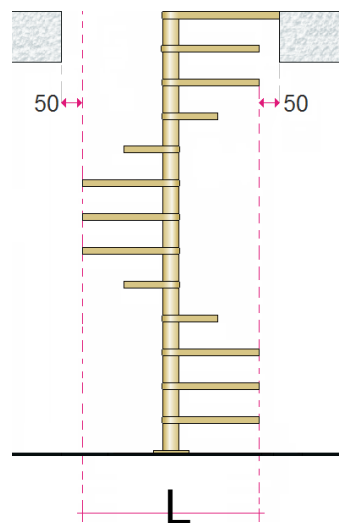

Diametri disponibili, senso di salita, forme e possibili pianerottoli d'arrivo con dimensione d'uscita per scale a pianta circolare e a pianta quadra.

Available diameters, staircase rotation, shapes and possible arrival landings with exit dimension for round and well staircases.

Diamètres disponibles, sens de rotation, formes et possibles paliers d'arrivée avec dimension de sortie pour escaliers ronds ou carrés.

APERTURA GRADINI, TREADS OPENING, OUVERTURE DES MARCHES

FISSAGGIO ARRIVO SBARCO, FIXING OF THE ARRIVAL LANDING, FIXATION DU PALIER D'ARRIVÉE

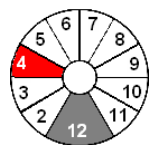

L 1000 ÷ 1200

Y = 30°

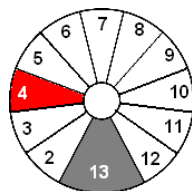

L 1400 - 1600

Y = 27°

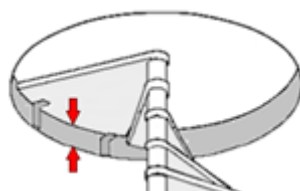

MIN 210

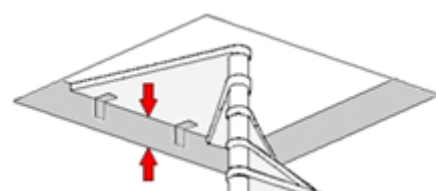

MIN 210

ALTEZZE E NUMERO GRADINI, FLOOR HEIGHTS AND TREADS NUMBER, HAUTEURS ET NOMBRE DES MARCHES - G11 ÷ G...

Ø 1000 ÷ 1600

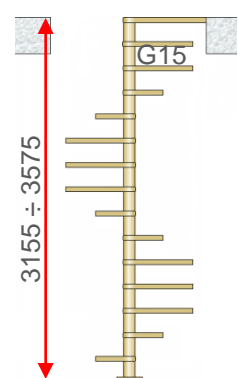
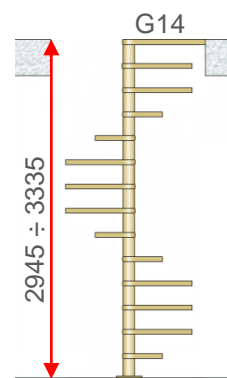
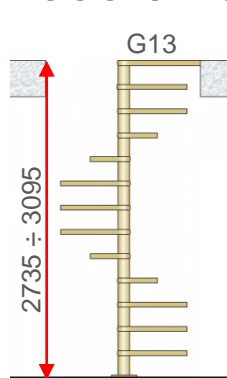
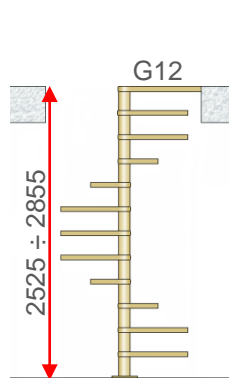
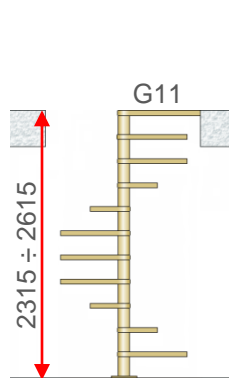

MIN 210 ÷ MAX 240

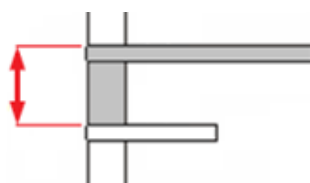

ECON

CARATTERISTICHE, FEATURES, CARACTÉRISTIQUES

ECON

CORRIMANO PVC GRIGIO
PVC HANDRAIL GREY
MAIN COURANTE PVC GRIS

RINGHIERA A COLONNE Ø 22mm

BANISTER WITH SPINDLES Ø 22mm

GARDE-CORPS AVEC
COLONNETTES Ø 22mm

METAL

PALO METAL
METAL CENTRAL POLE
POTEAU EN MÉTAL

PORTATA 200 Kg/m²
LOAD 200 Kg/m²
PORTÉE 200 Kg/m²



Ø 1100 ÷ 1600



SENSO DI SALITA: ORARIO E ANTIORARIO
USO INTERNO
STAIRCASE ROTATION: CLOCKWISE AND ANTICLOCKWISE
INTERNAL USE
SENS DE MONTÉE: HORAIRE OU ANTI-HORAIRE
USAGE INTÉRIEUR

ECON

CARATTERISTICHE, FEATURES, CARACTÉRISTIQUES

ECON FX

CORRIMANO PVC GRIGIO
PVC HANDRAIL GREY
MAIN COURANTE PVC GRIS

RINGHIERA A COLONNE Ø 22mm
E CAVI IN ACCIAIO Ø 4mm
BANISTER WITH SPINDLES Ø 22mm
AND STEEL WIRES Ø 4mm
GARDE-CORPS AVEC
COLONNETTES Ø 22mm
CABLES ET ACIER Ø 4mm

METAL
S235JR

PALO METAL
METAL CENTRAL POLE
POTEAU EN MÉTAL

PORTATA 200 Kg/m²
LOAD 200 Kg/m²
PORTÉE 200 Kg/m²

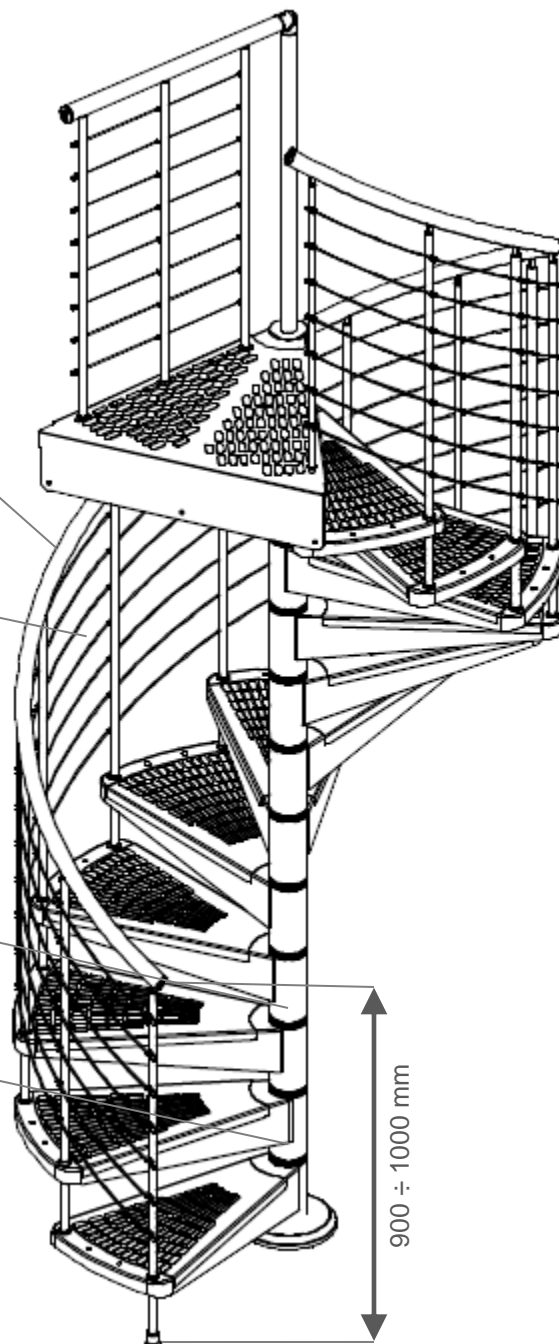

Ø 1100 ÷ 1600 mm



Ø 1000 mm

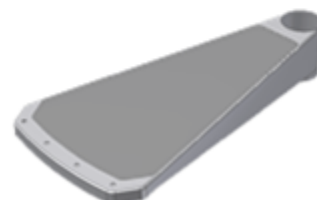

ALZATA :
HUTEUR:
210 ÷ 240 mm

SENSO DI SALITA: ORARIO E ANTIORARIO
USO ESTERNO
STAIRCASE ROTATION: CLOCKWISE AND ANTICLOCKWISE
EXTERNAL USE
SENS DE MONTÉE: HORAIRE OU ANTI-HORAIRE
USAGE EXTÉRIEUR

ECON

BALAUSTRÉ PROTEZIONE FORO, FLOOR PROTECTION BALUSTRADE, GARDE-CORPS ÉTAGE POUR LA TRÉMIE

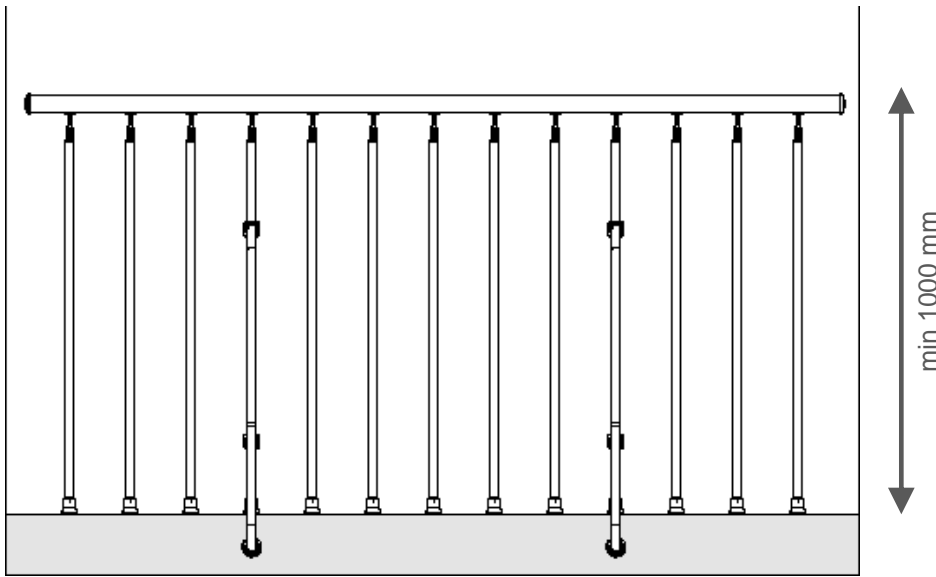

max 1000 mm

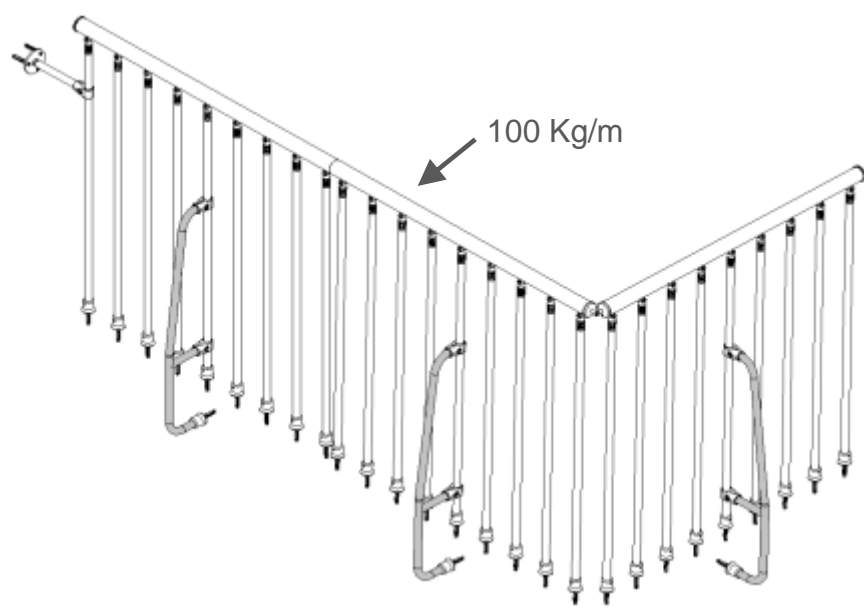

CORRIMANO OVC – PVC handrail - Main courante PVC

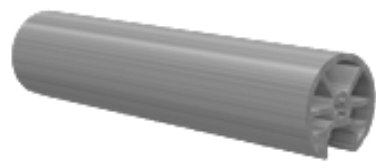

ECON

BALAUSTRE PROTEZIONE FORO, FLOOR PROTECTION BALUSTRADE, GARDE-CORPS ÉTAGE POUR LA TRÈMIE

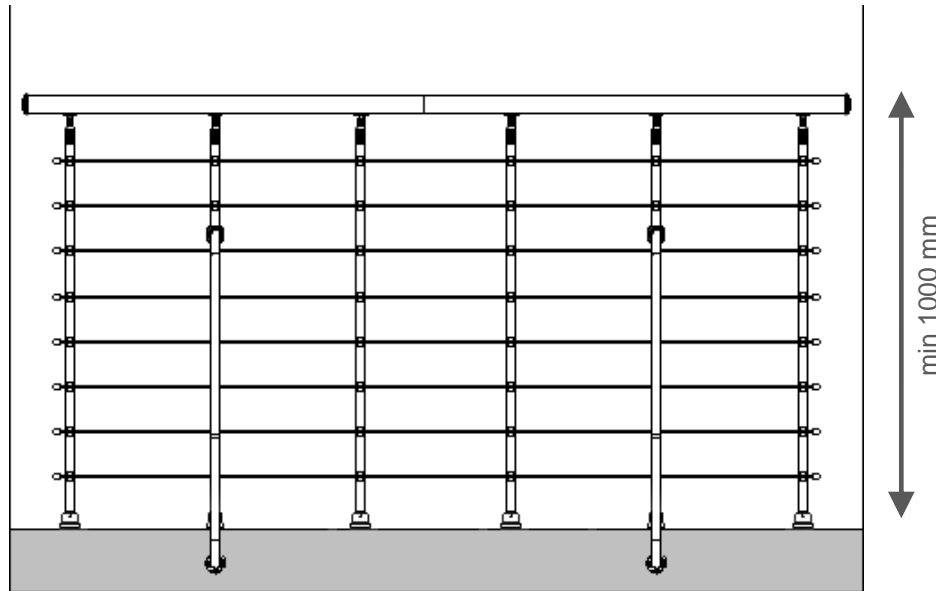

ECON FX

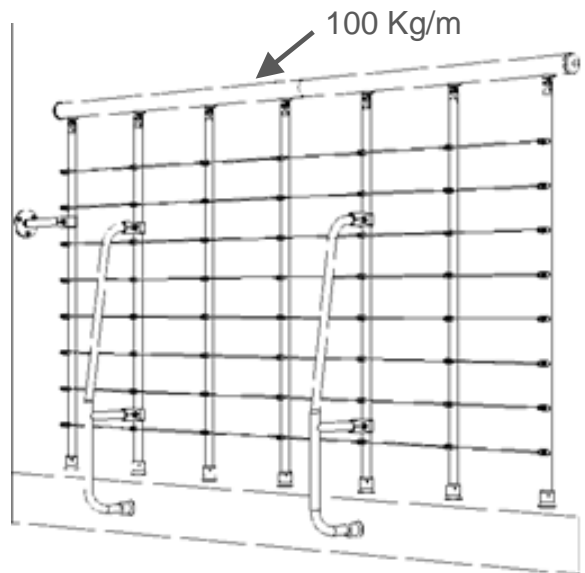

CORRIMANO OVC – PVC handrail - Main courante PVC



ECON

COLORS METAL ECON FX-Z



Zinco

COLORS METAL ECON FX-VZ

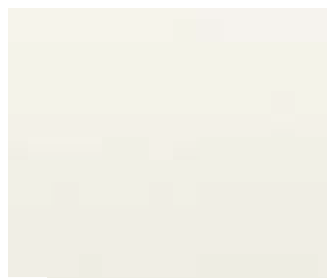

RAL 9001
Bianco
White
Blanc
Weiss
Blanco

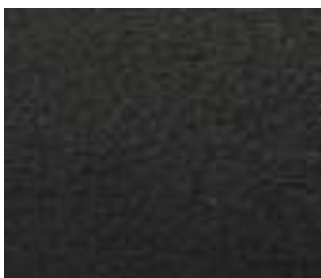

95 RG
Nero raggrinzato
Wrinkled Black
Noir granité
Schwarz runzlig
Negro arrugado



97 RG
Grigio raggrinzato
Wrinkled Grey
Gris granité
Grau runzlig
Gris arrugado

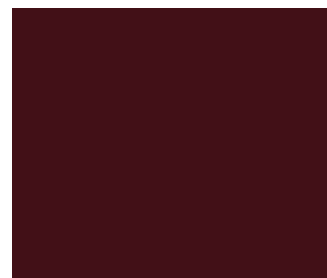

RAL 3005
Bordeaux



RAL 5002
Blu
Blue
Bleu
Blau
Azul



RAL 6026
Verde
Green
Vert
Grün
Verde



RAL 3000
Rosso
Red
Rouge
Rot
Rojo



RAL 1021
Giallo
Yellow
Jaune
Gelb
Amarillo