

Forme · Formes · Shapes · Formen · Formas

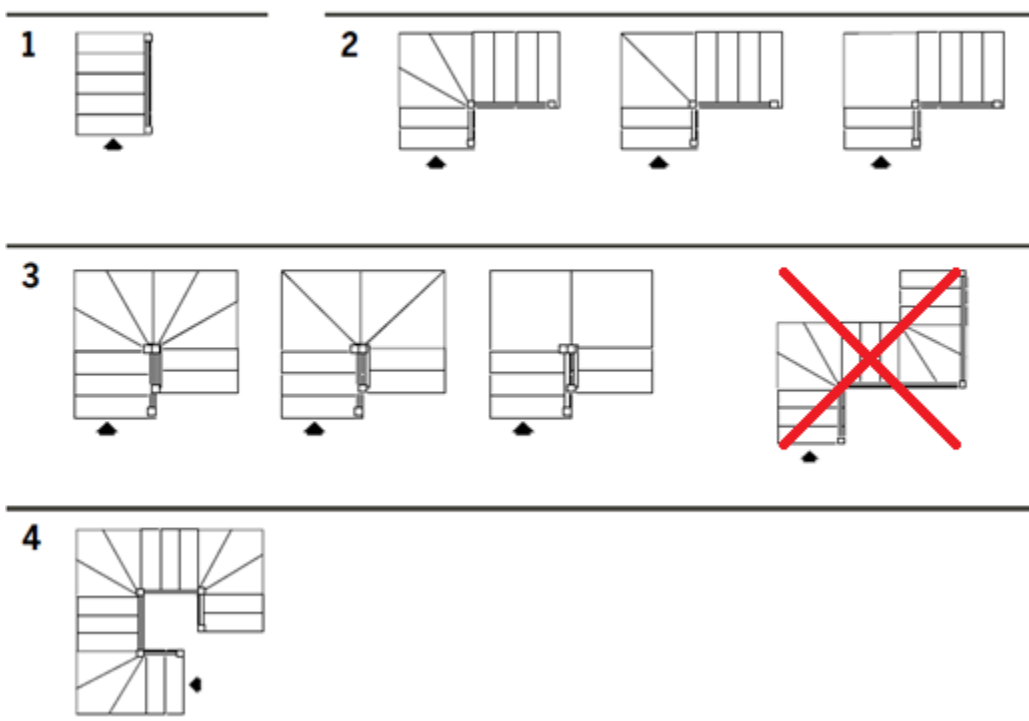

| | G10 | G11 | G12 | G13 | G14 | G15 | G16 | G17 |
|---|------|------|------|------|------|------|------|------|
| h | 1870 | 2040 | 2210 | 2380 | 2550 | 2720 | 2890 | 3060 |
| | 2310 | 2520 | 2730 | 2940 | 3150 | 3360 | 3570 | 3780 |

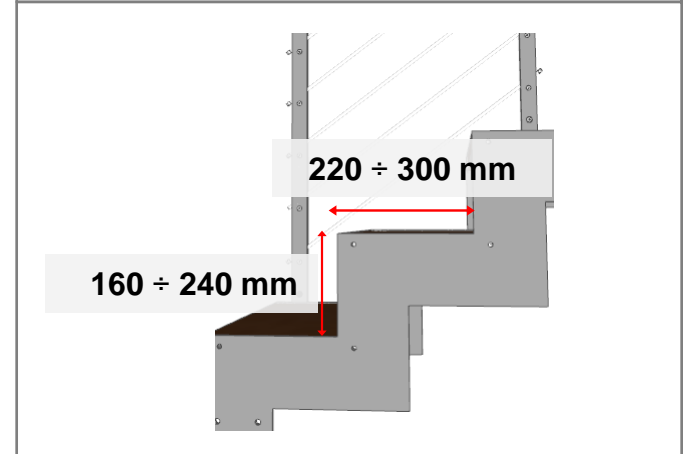

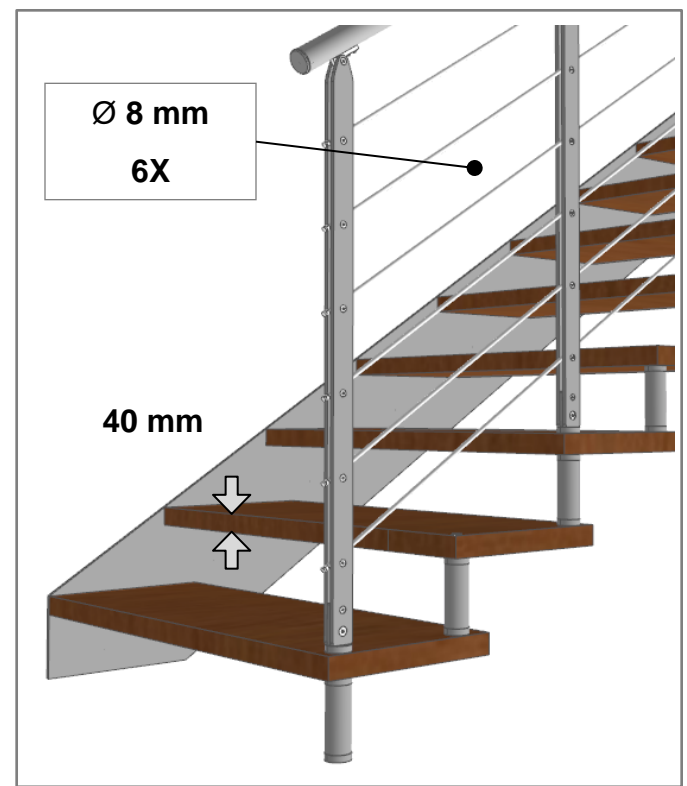
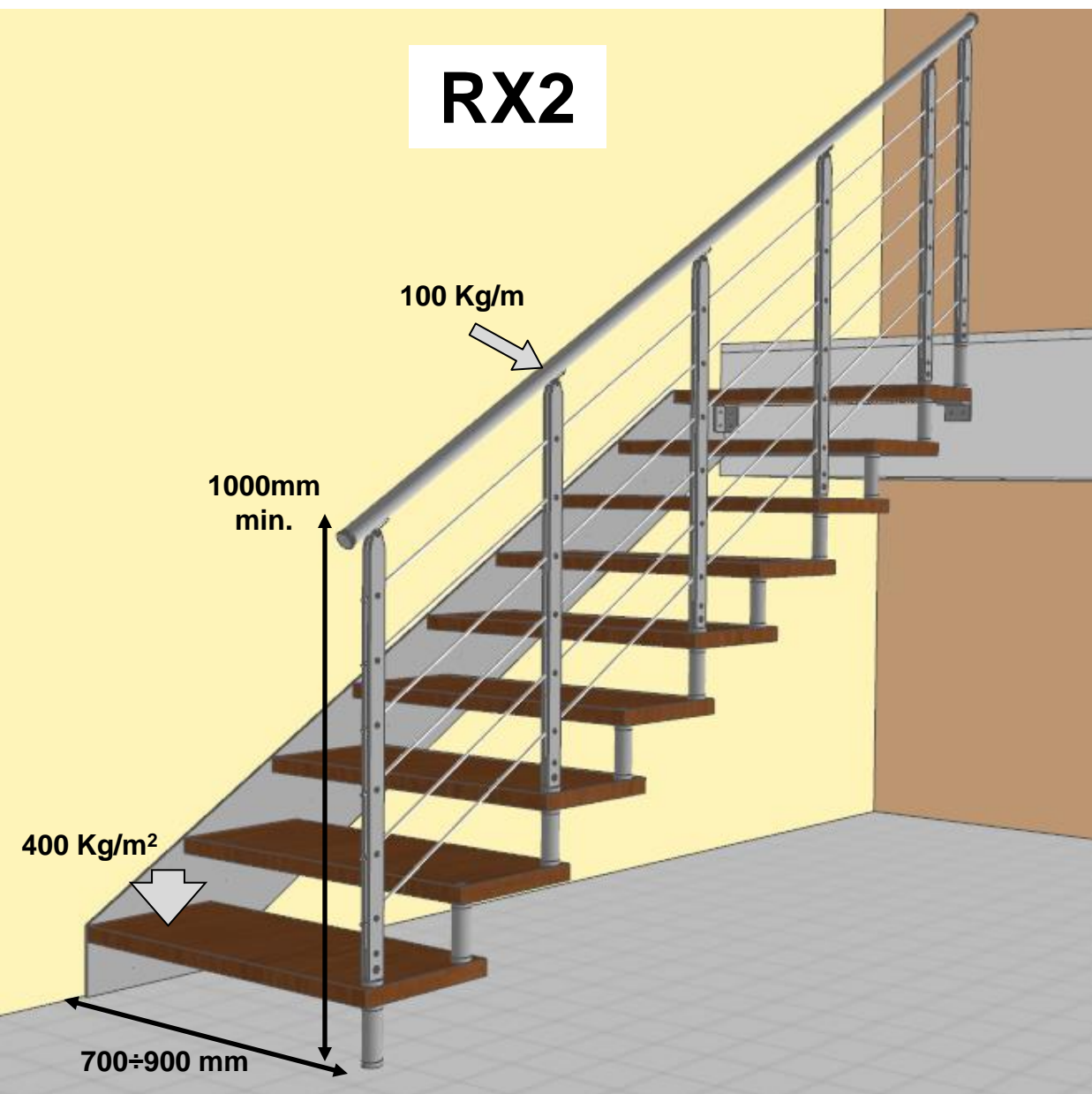

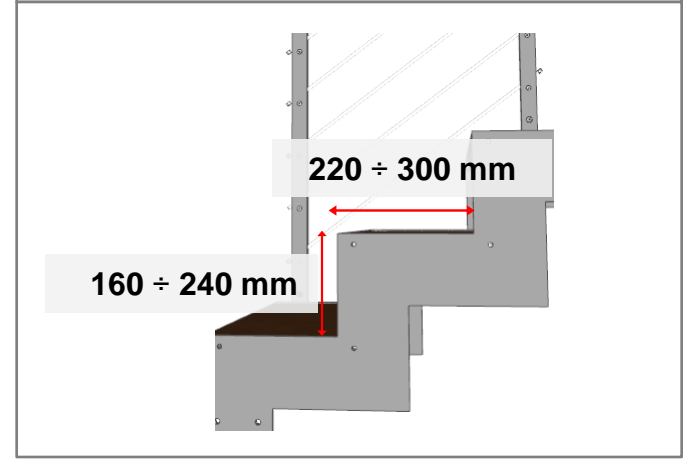
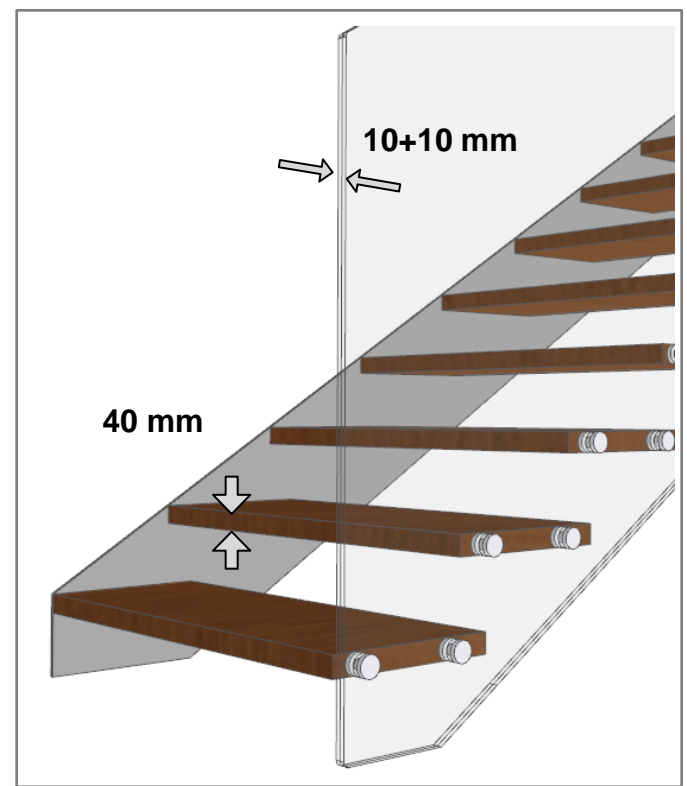
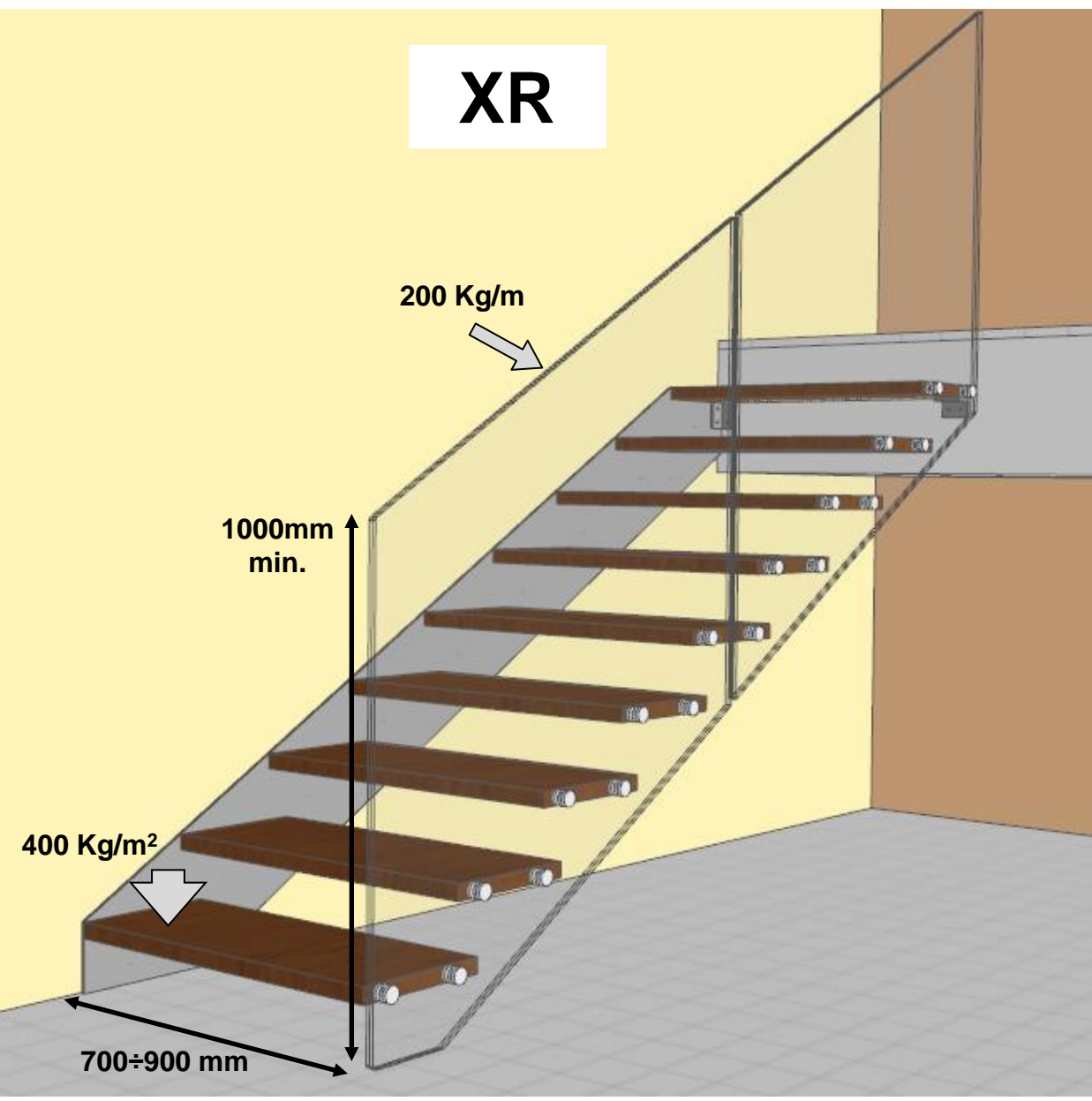

Schemi arrivo, modèles d'arrivée, arrival patterns

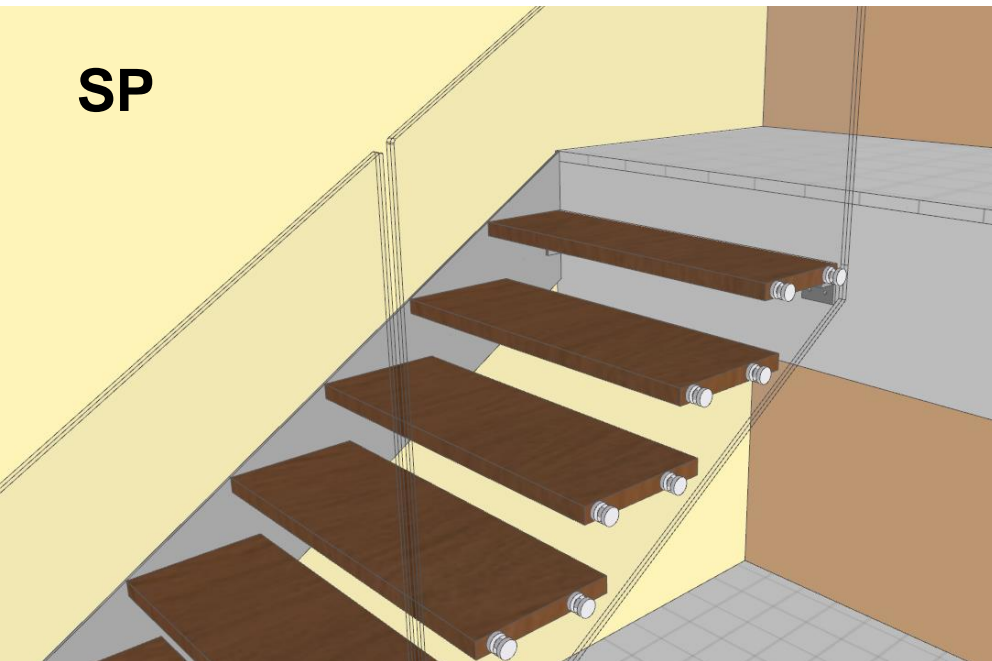

SP

Arrivo gradino con alzata, arrivée de la marche avec hauteur, arrival down the floor

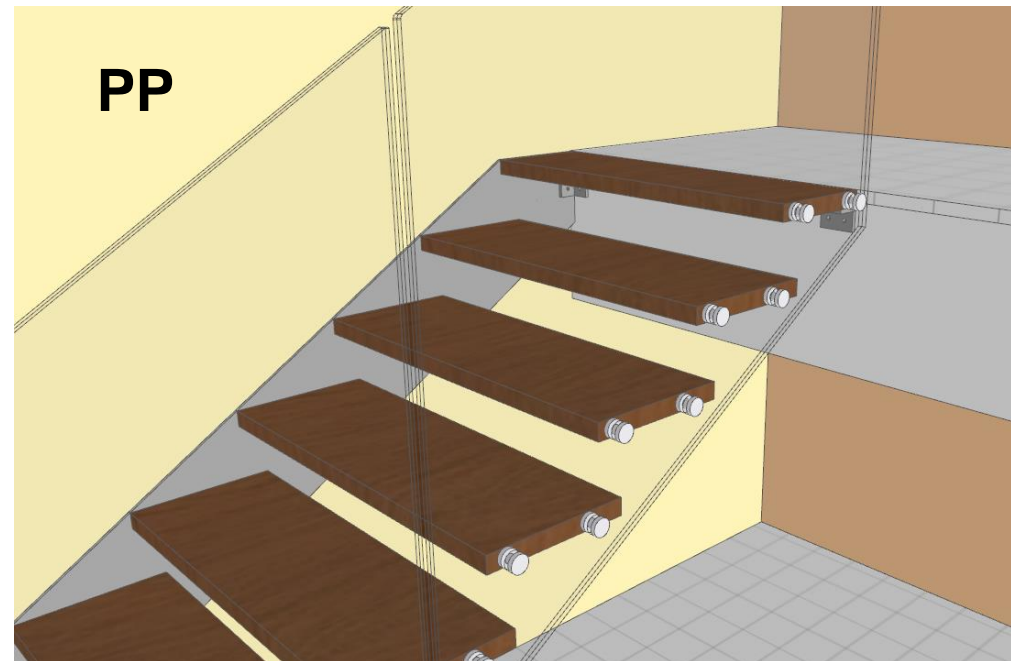

PP

Arrivo con gradino pari pavimento, arrivée au sol, arrival to the floor

Schemi partenze, plans de départs, departures schemes

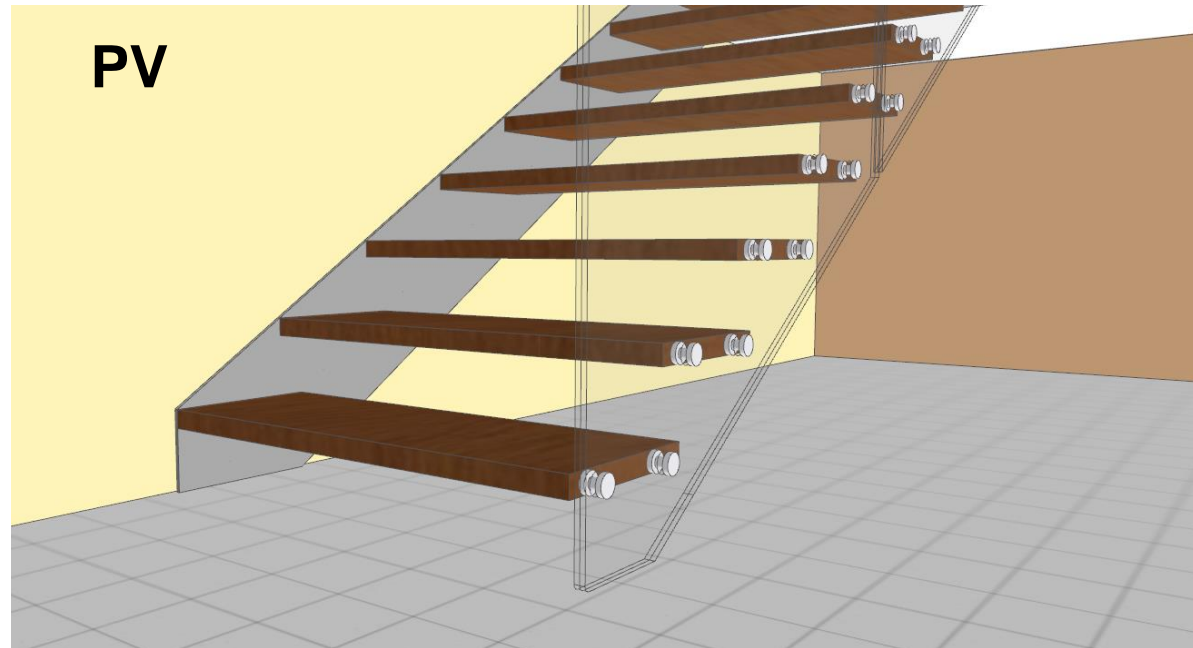

Partenza a pavimento, marche de départ au sol, starting floor

Balaustre al piano, garde-corps de trémie, balustrade

Model RX2

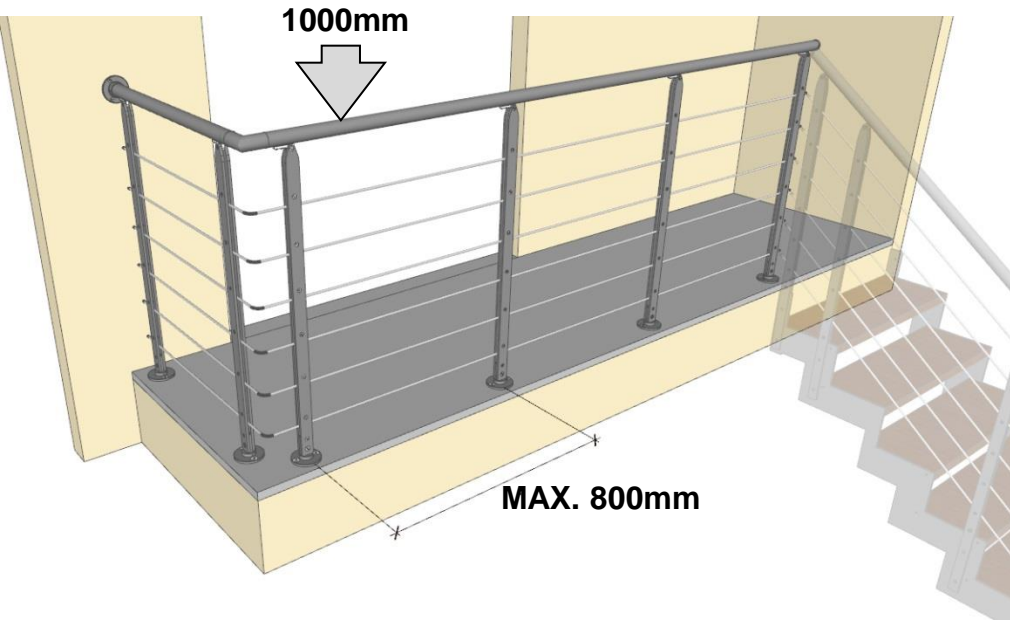

Balaustra con fissaggio a pavimento,

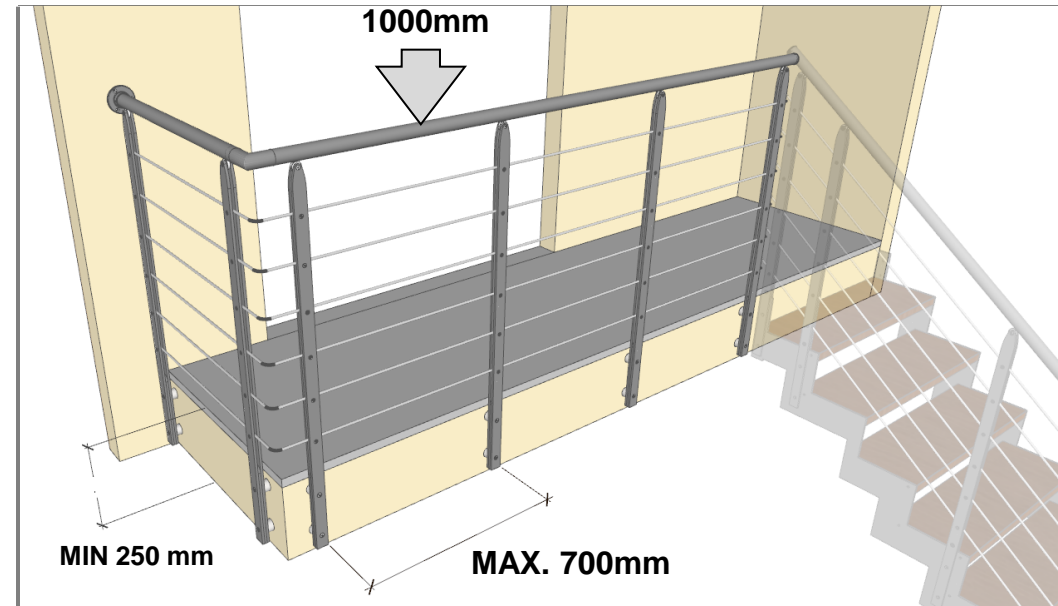

Balaustra con fissaggio a soletta,

Balaustre al piano, garde-corps de trémie, balustrade

Model XR

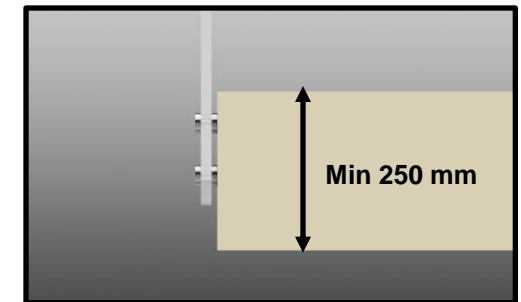
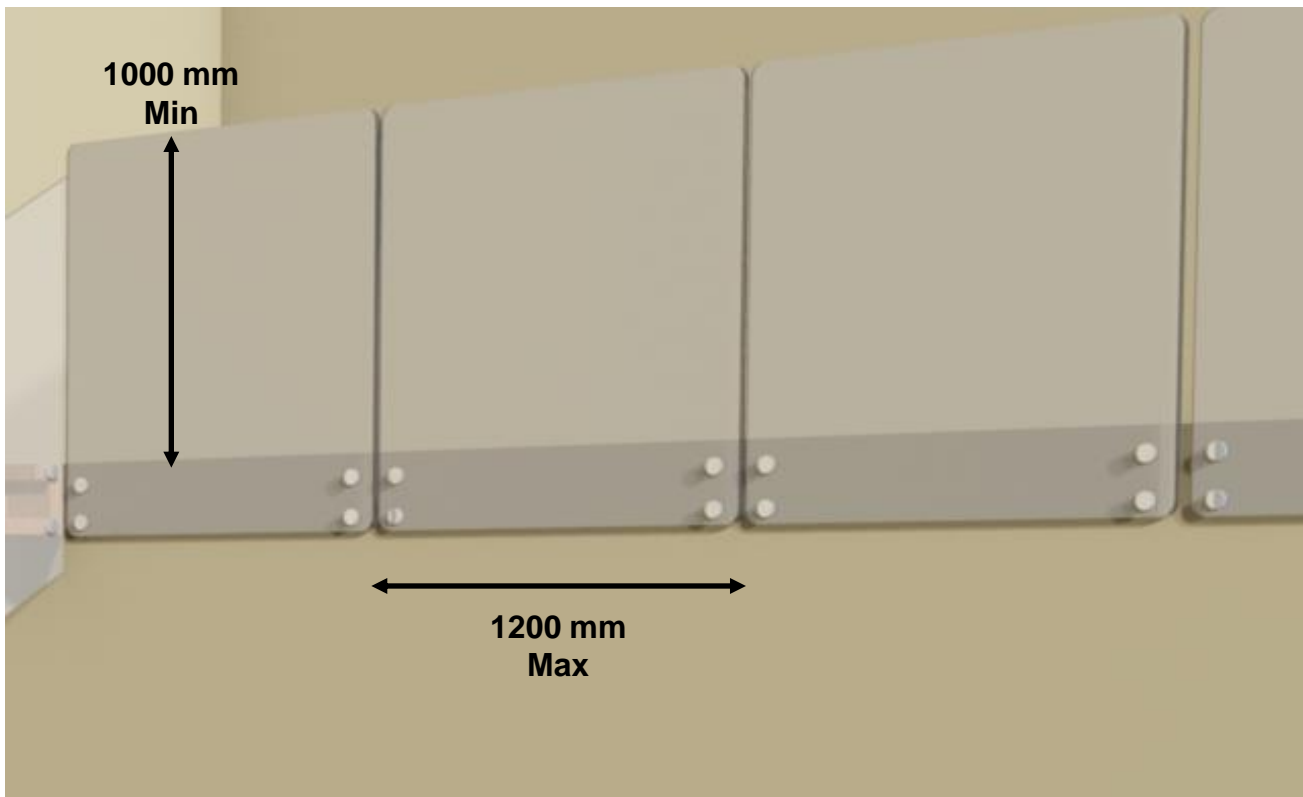

OPTIONAL

