



 Scala a chiocciola disponibile con forma tonda;
Gradini in metallo;
Palo centrale in metallo;
Ringhiera con colonne o cavetti in acciaio inox;
Corrimano disponibile solo in PVC grigio.

 Spiral staircase available with round shape;
Metal steps;
Metal central pole;
Banister with spindles or stainless cables;
PVC handrail, grey color.

 Escalier en colimaçon disponible dans la forme ronde;
Marches en métal;
Poteau central en métal ;
Garde-corps avec colonnes ou câbles en acier inoxydable ;
Main courante en PVC gris.

 Spindeltreppe mit rundem Form erhältlich;
Stufen aus Metall;
Zentrale Metallstange;
Geländer mit Säulen oder Edelstahlkabel;
Handlauf aus PVC Grau.

 Escalera de caracol disponible en forma redonda;
Escalones en metal;
Poste central de metal;
Barandilla con columnas o cables de acero inoxidable;
Pasamanos en PVC gris.

Dettagli tecnici

Technical details - Détails techniques
Technische Details - Ficha técnica

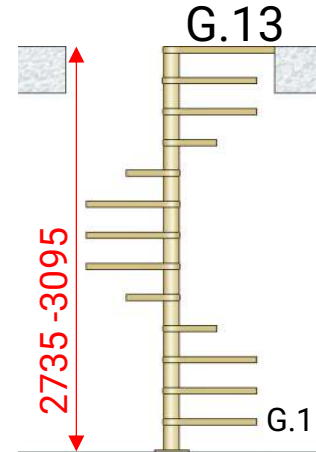
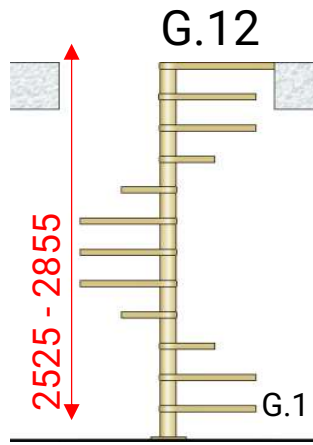
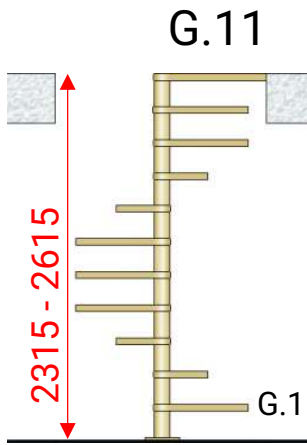

IMBALLO

Dim. 115x97x74 cm
Peso: circa 190/250 kg.

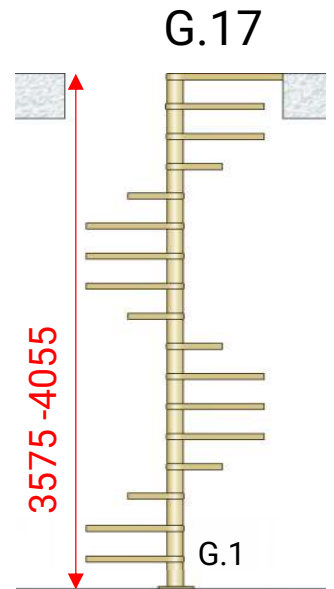
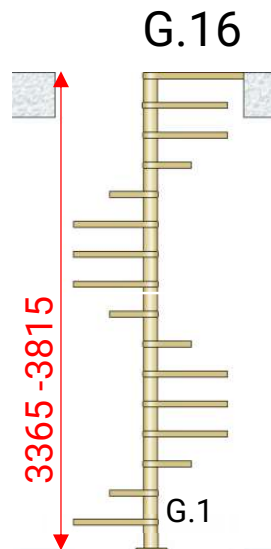
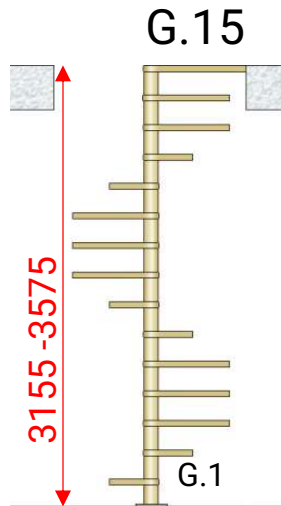
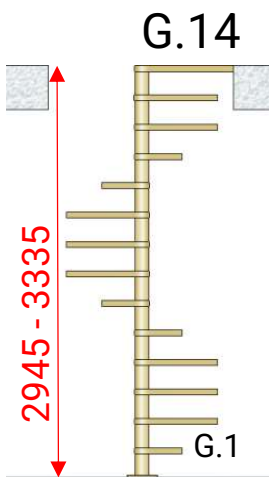

MIN 205 ÷ MAX 240

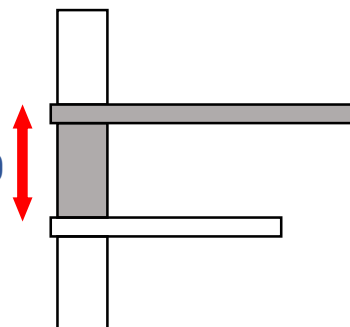

Dettagli tecnici Technical details - Détails techniques Technische Details - Ficha técnica

L	C1	C2	C3	P.U.	P.M.
Ø1200	624	711	620	499	155,6
Ø1400	716	813	720	599	163,6
Ø1600	808	915	820	699	187,0

FORO, WELL, TRÊMIE, LOCH, HUECO

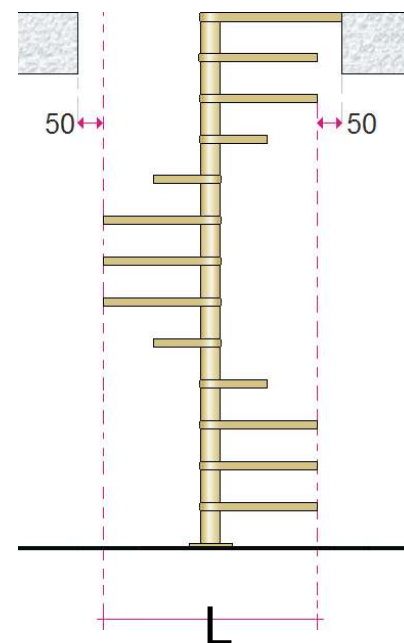
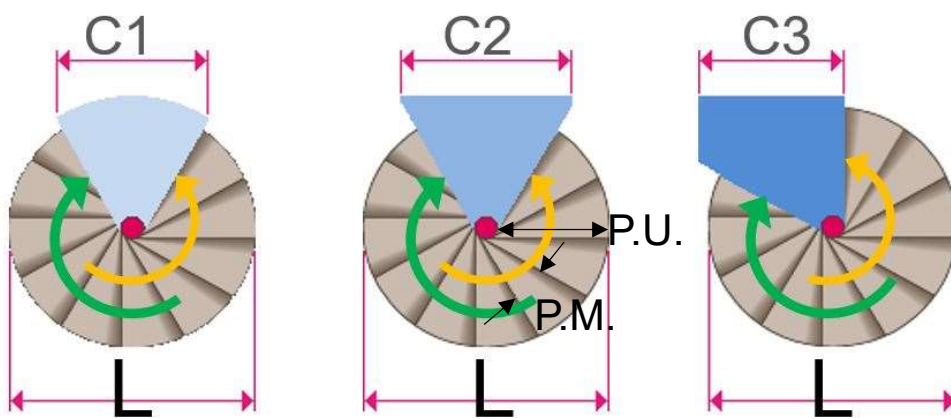

FISSAGGIO ARRIVO SBARCO, FIXING OF THE ARRIVAL LANDING, FIXATION DU PALIER D'ARRIVÉE, BEFESTIGUNG DES ANKUNFTSPODESTS

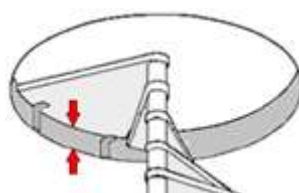

MIN 210

APERTURA GRADINI, TREADS OPENING, OUVERTURE DES MARCHES, ÖFFNUNG DER STUFEN, APERTURA DE LOS ESCALONES

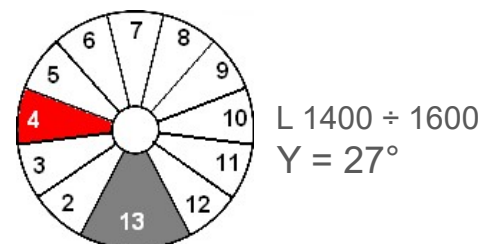
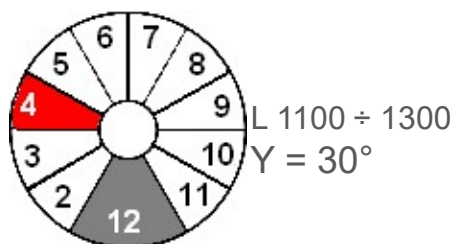

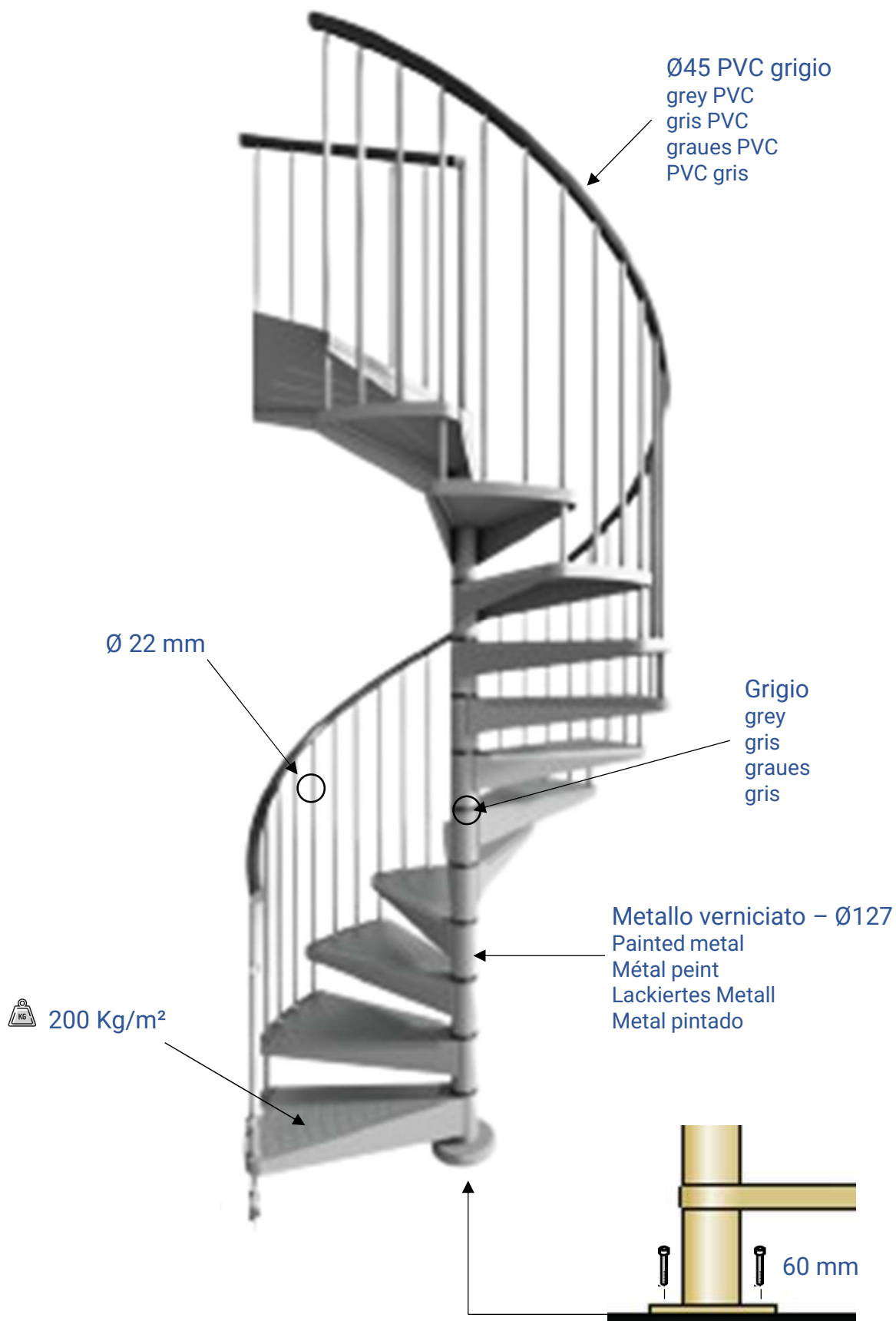

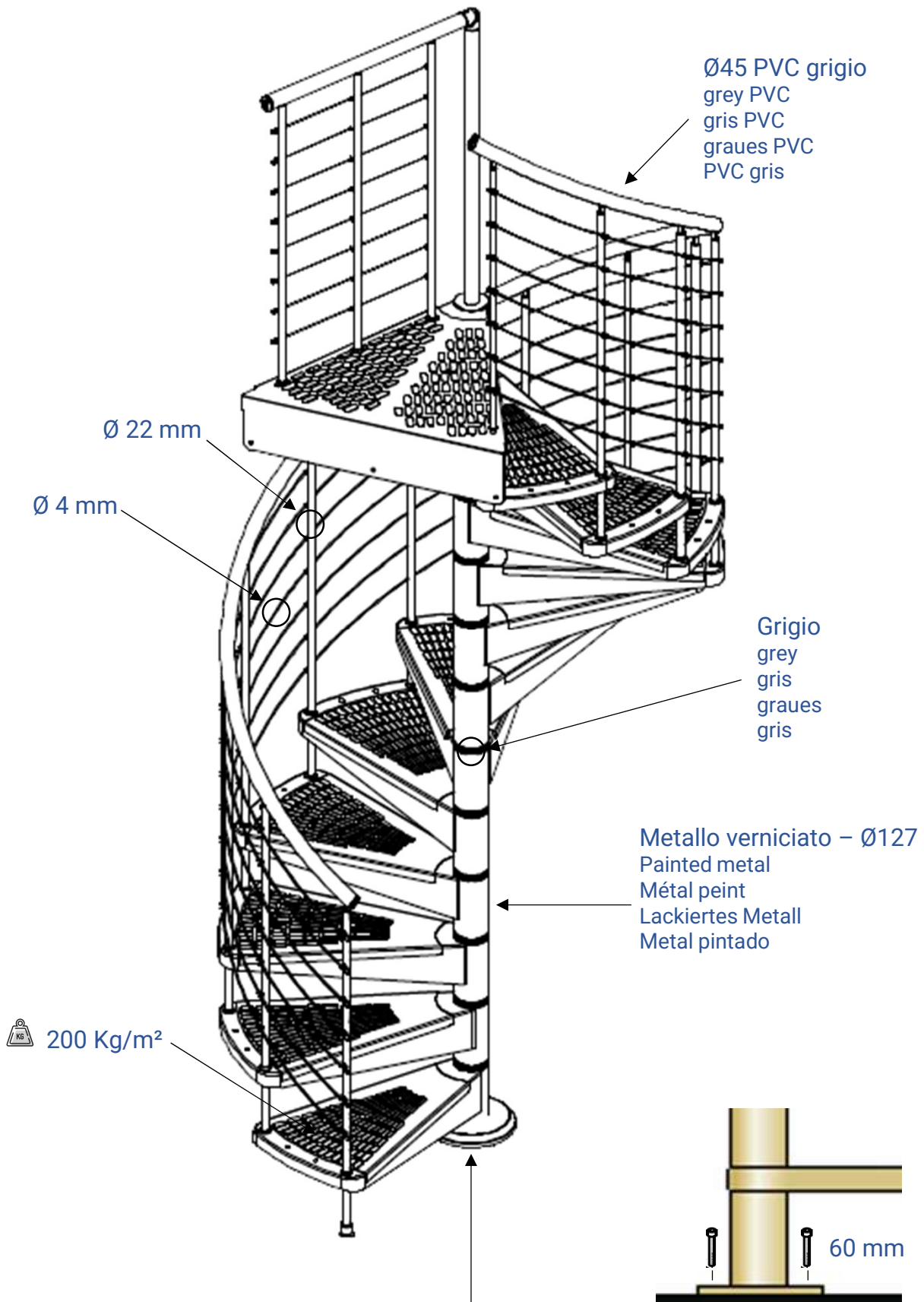

STAR 04

Balaustra

Balustrade – Balustrade
Balustrade - Balaustrada

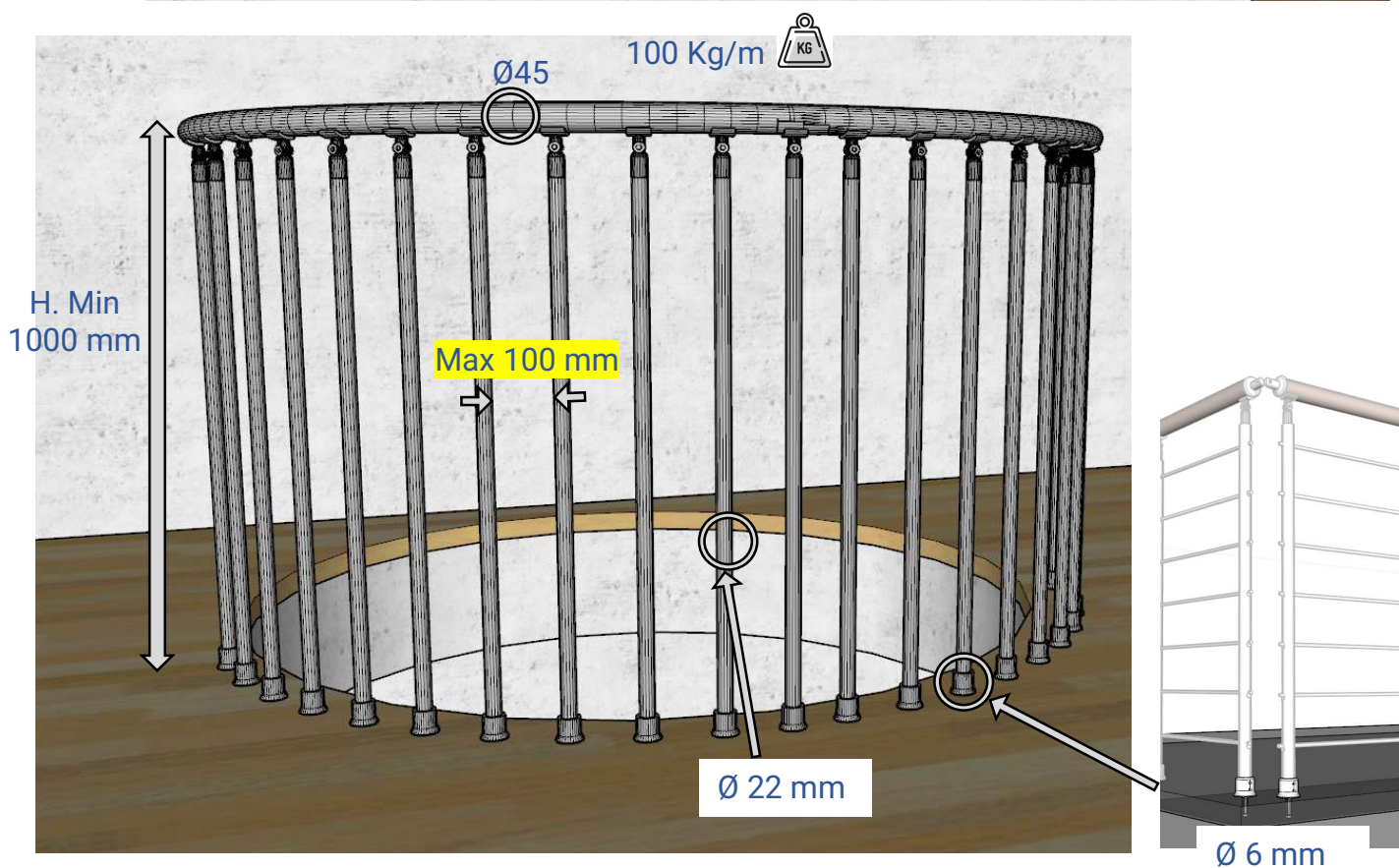
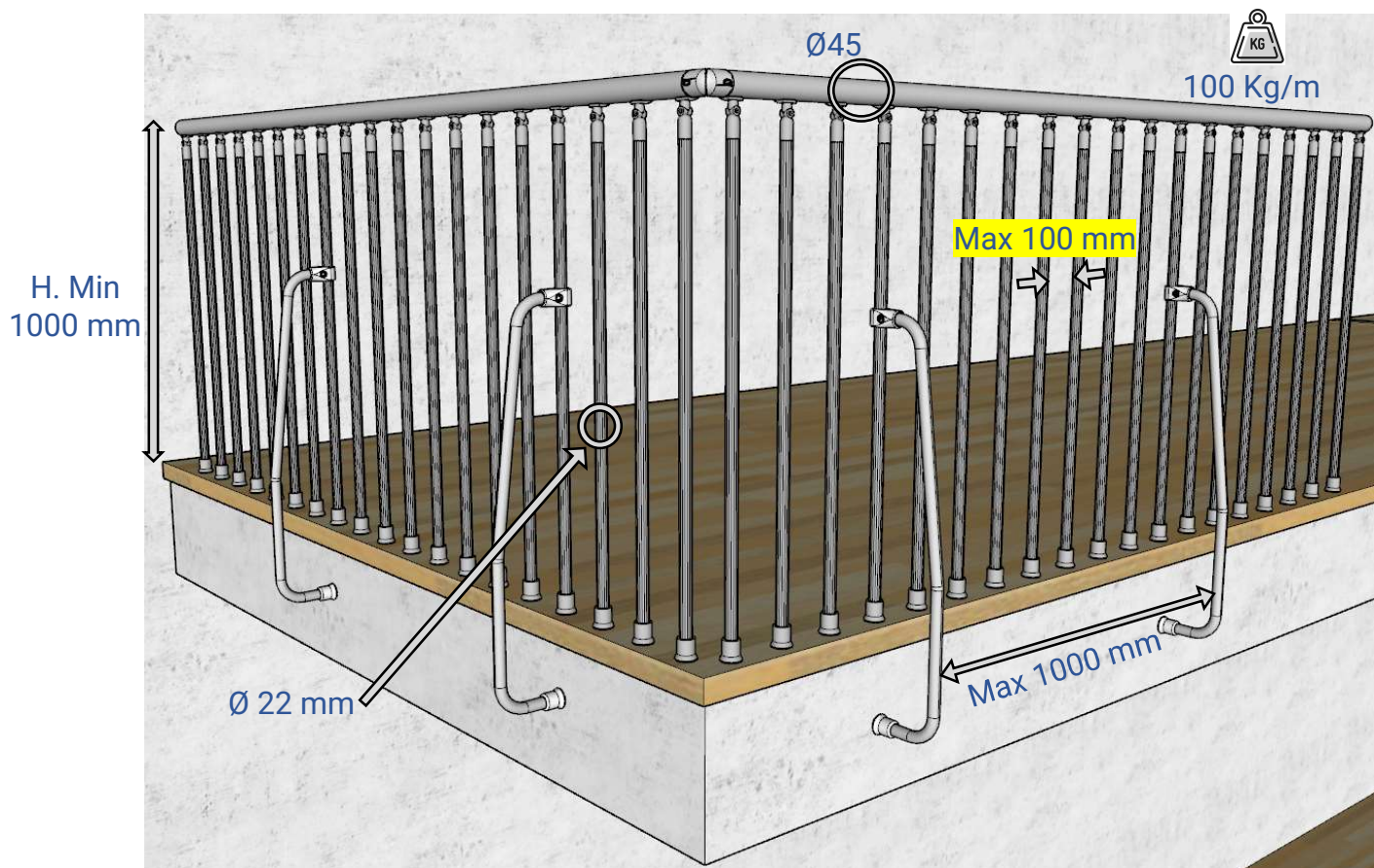

Balaustra
Balustrade – Balustrade
Balustrade - Balaustrada

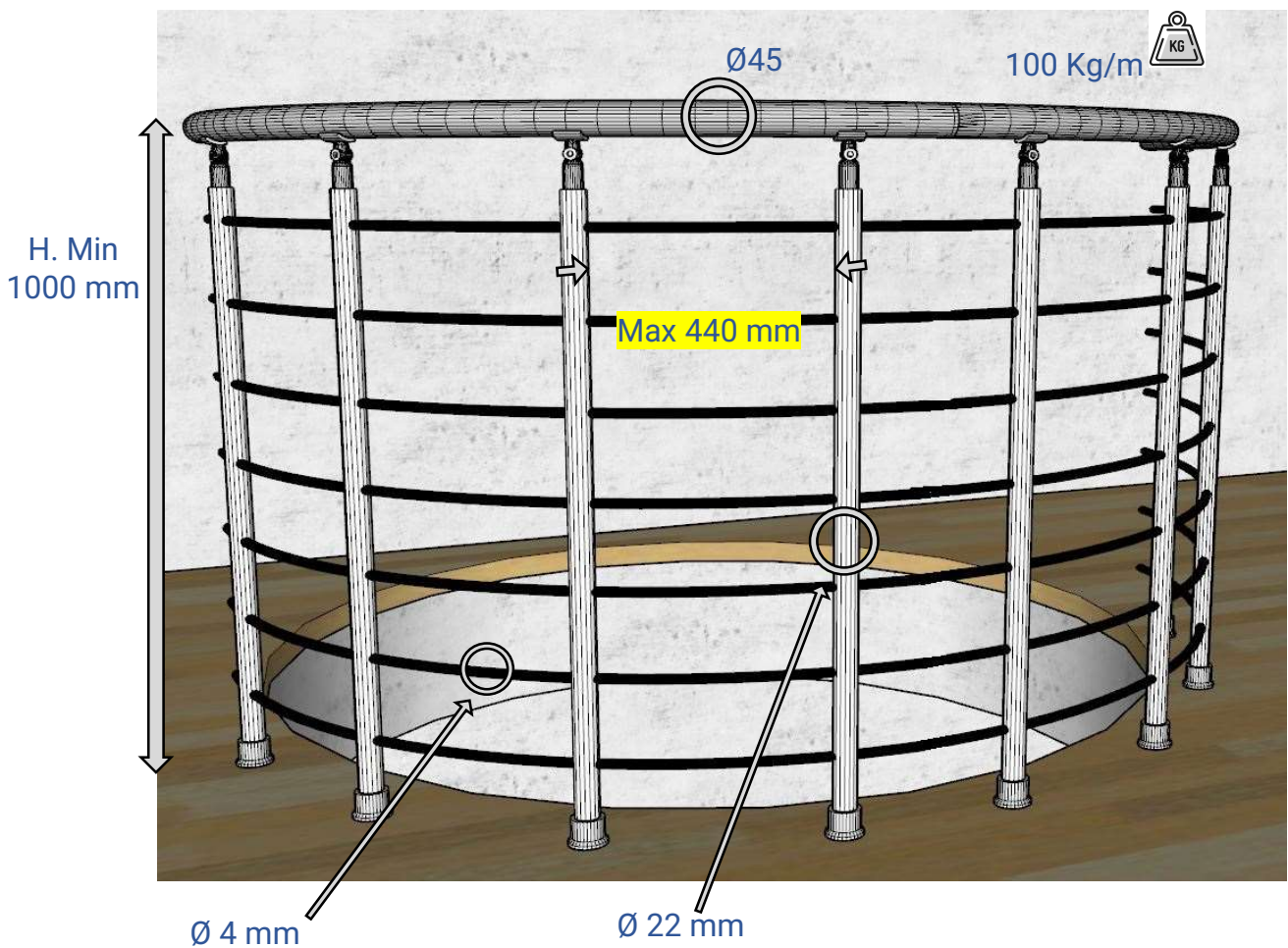
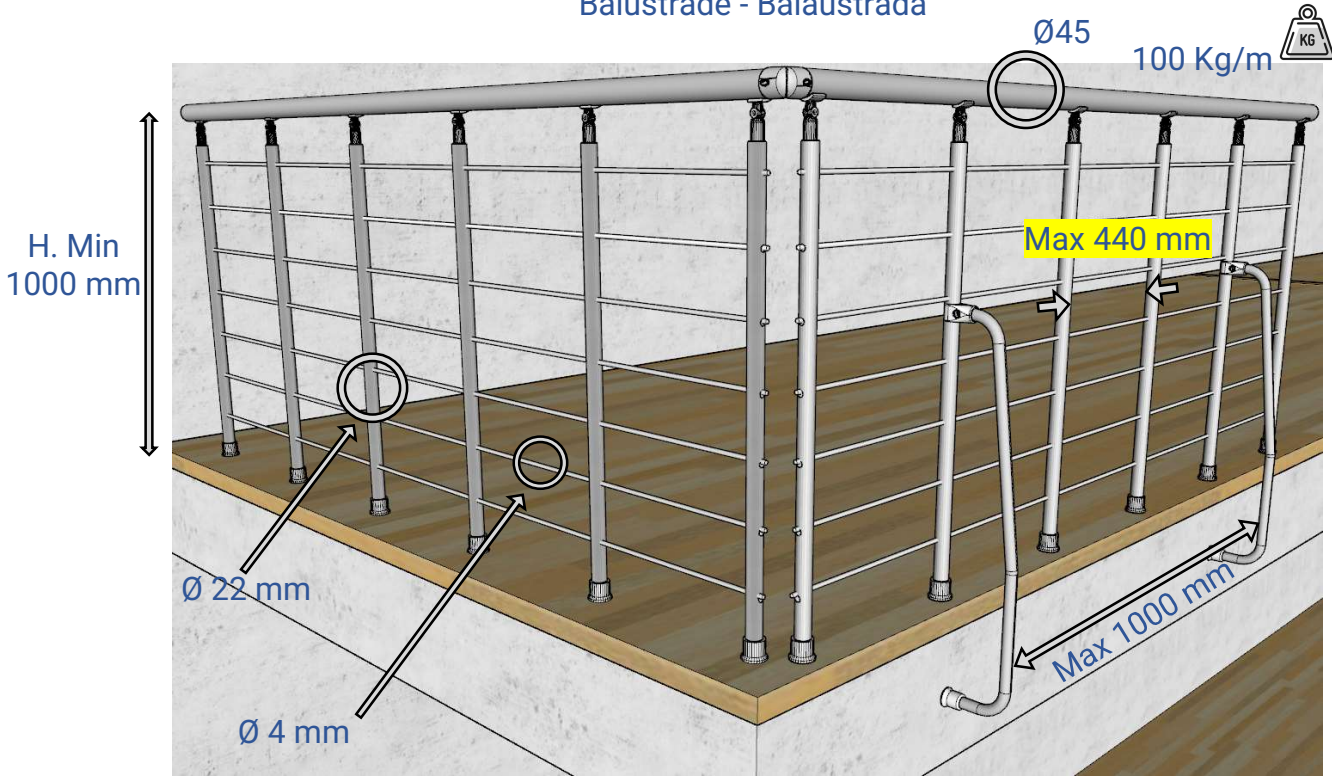

Sbarco su misura

Landing on measure - Palier sur mesure
Podest nach Maß - Desembarque personalizado

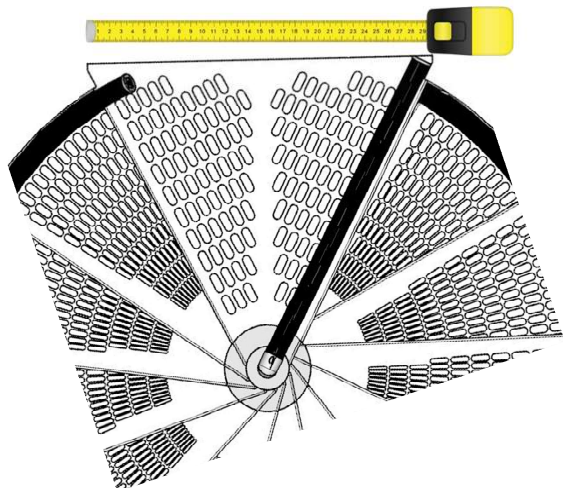

Corrimano a muro

Wall handrail - Main courante au mur
Wand-Handlauf, pasamanos de pared



Scala sovrapposta

Overlapping staircase - Escalier superposé,
überlagerte Treppe - Escalera superpuesta

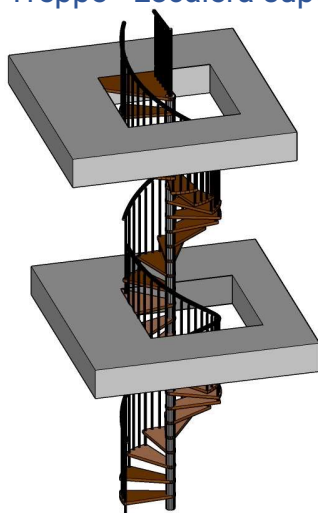

Piastra incollata

Glued Plate - Plaque collée -
Geklebte Platte - Placa encolada

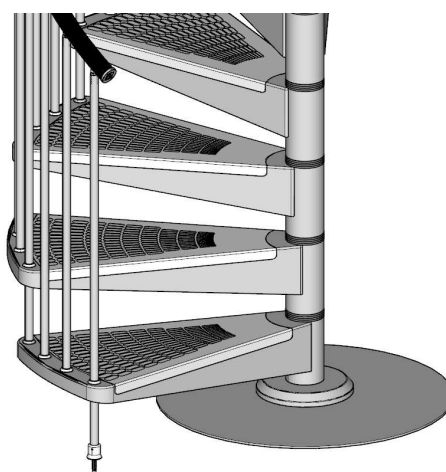

Pianerottolo tondo

Round landing - Palier ronde
Runde Podest - Desembarco redondo

