

Forme · Formes · Shapes · Formen · Formas

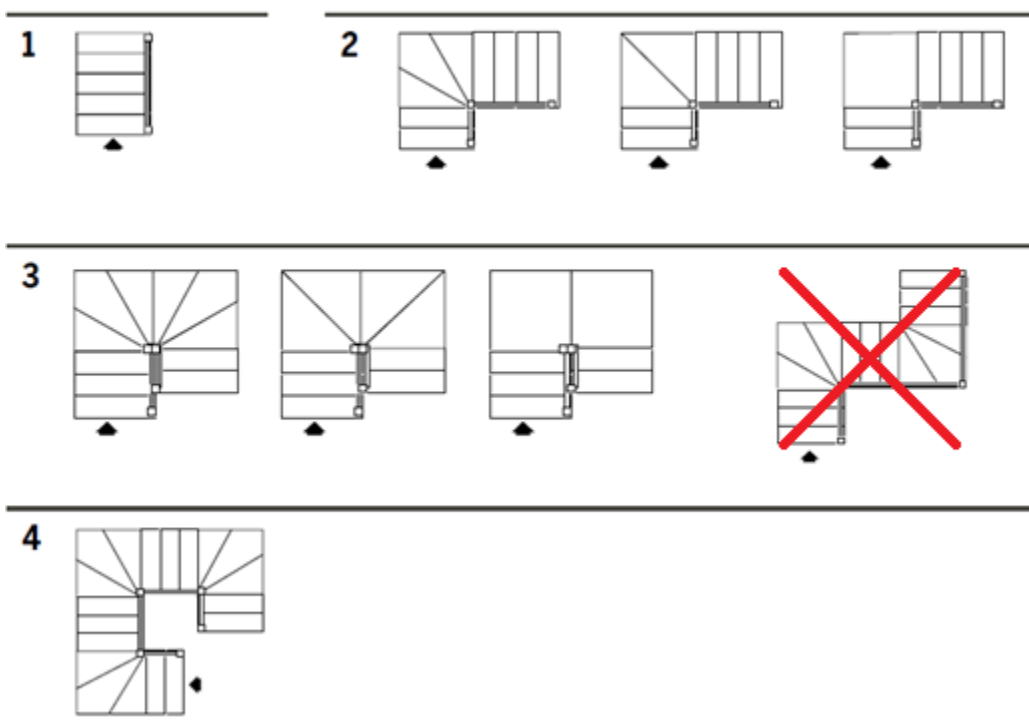

	G10	G11	G12	G13	G14	G15	G16	G17
h	1870	2040	2210	2380	2550	2720	2890	3060
	2310	2520	2730	2940	3150	3360	3570	3780

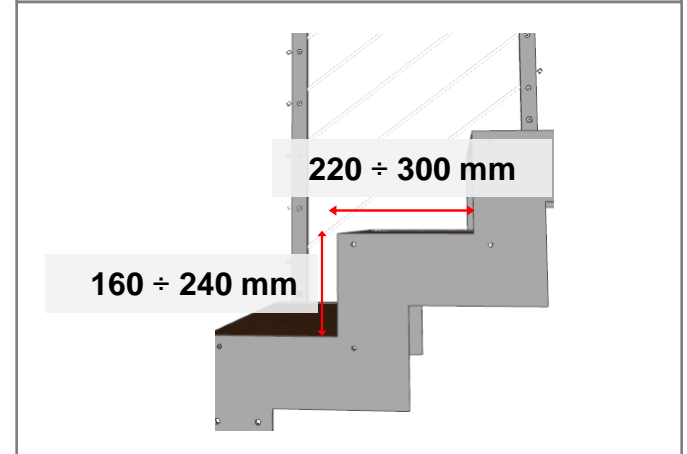

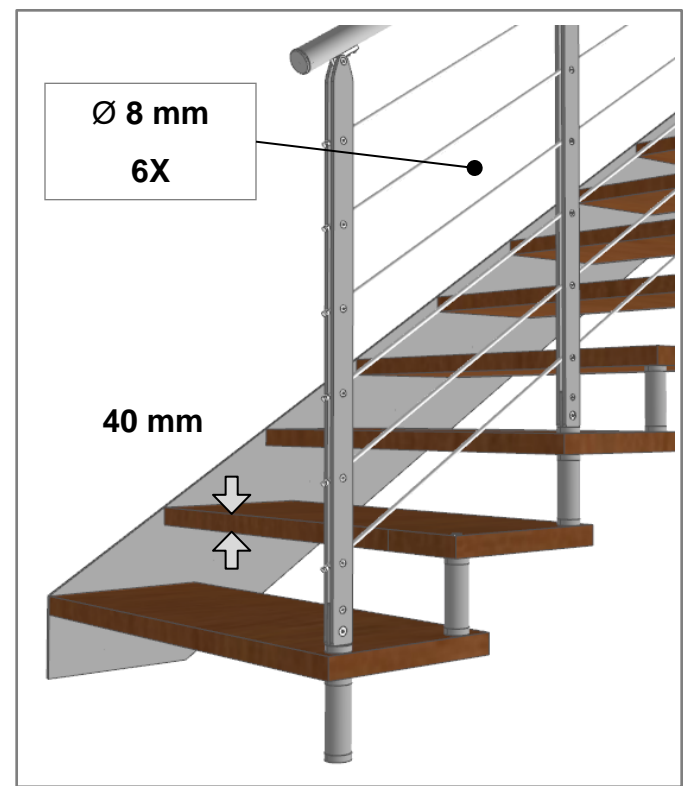
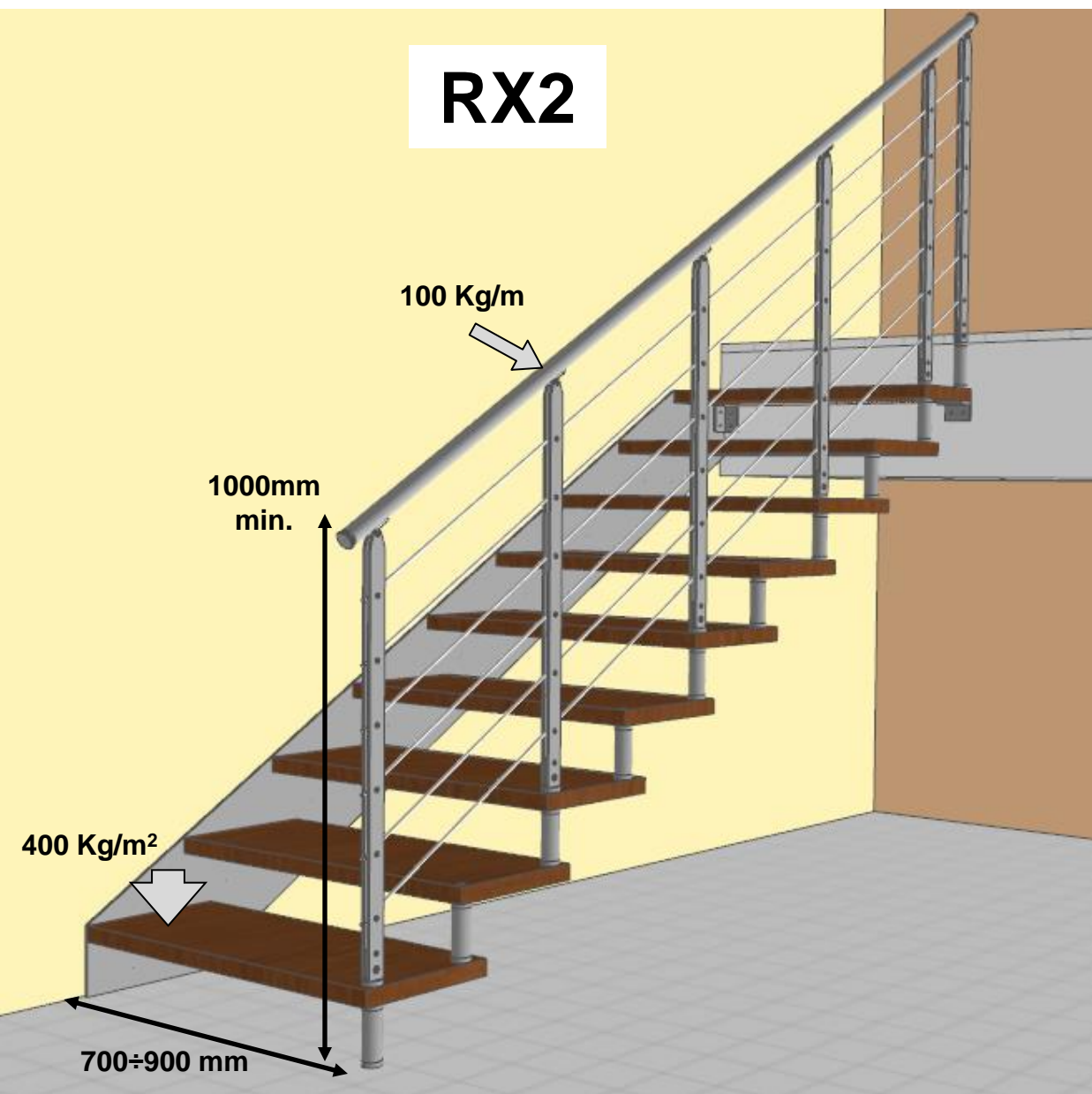

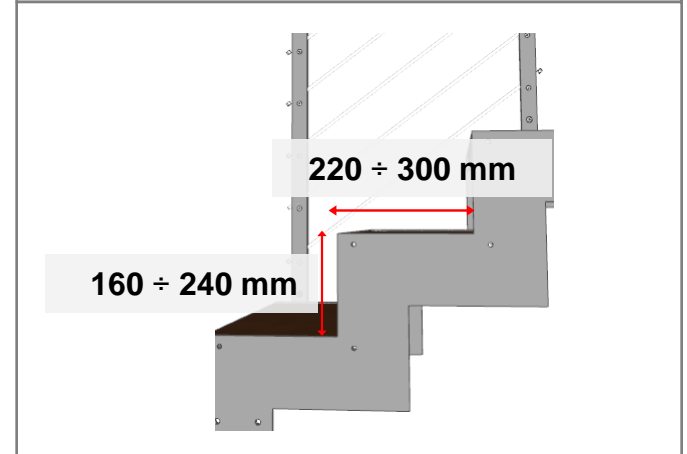
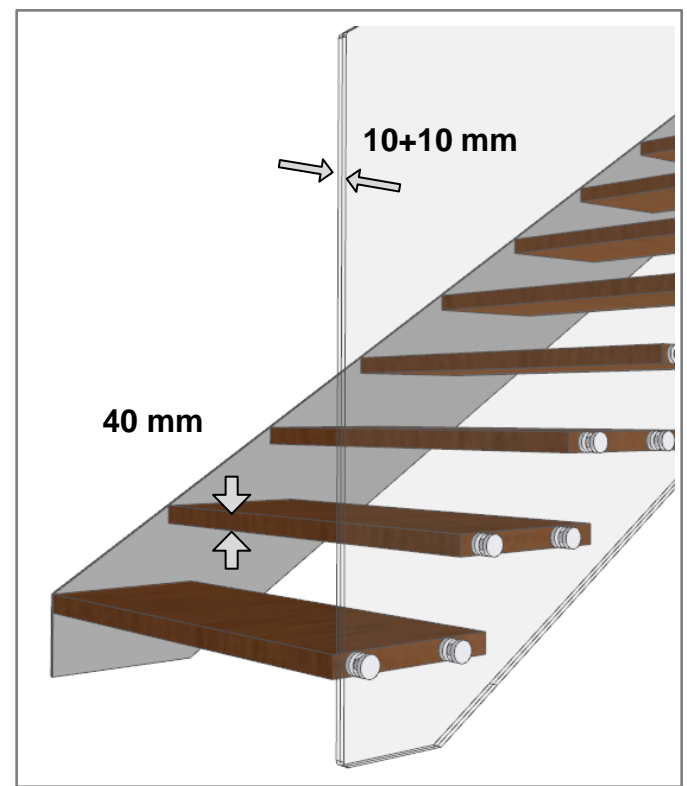
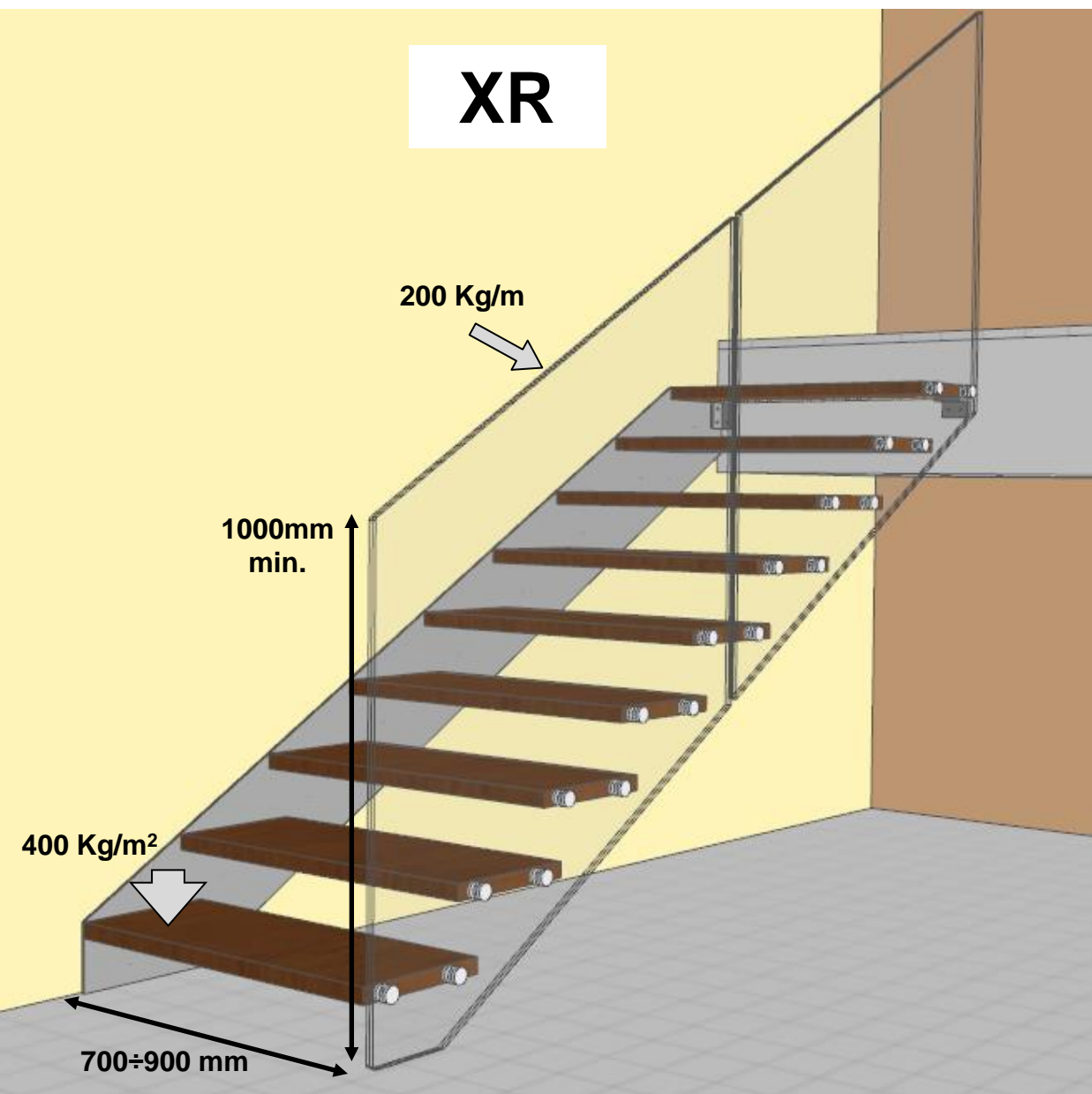

Schemi arrivo, modèles d'arrivée, arrival patterns

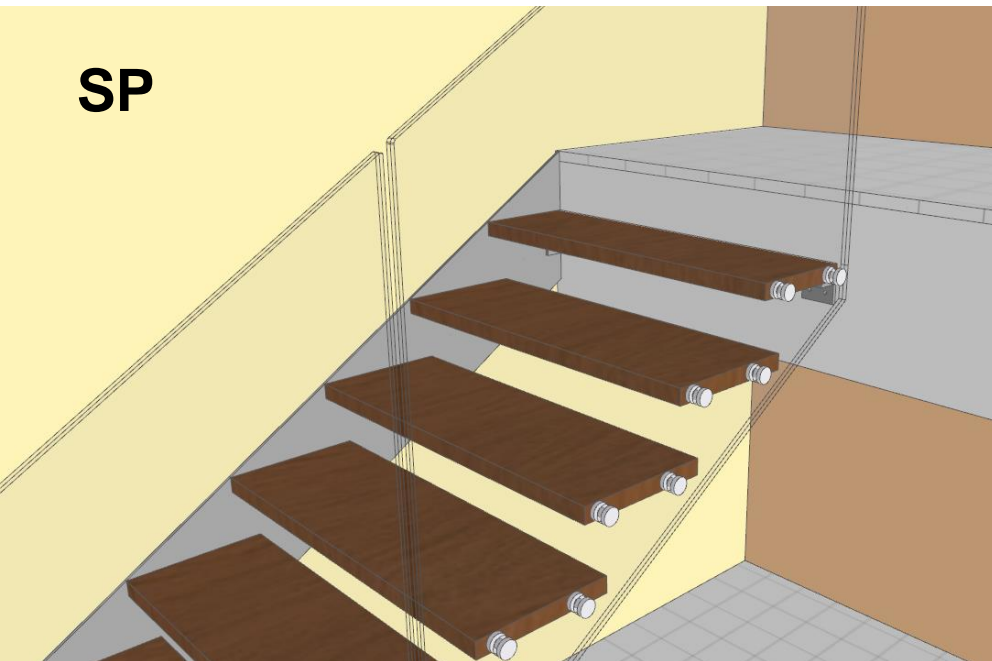

SP

Arrivo gradino con alzata, arrivée de la marche avec hauteur, arrival down the floor

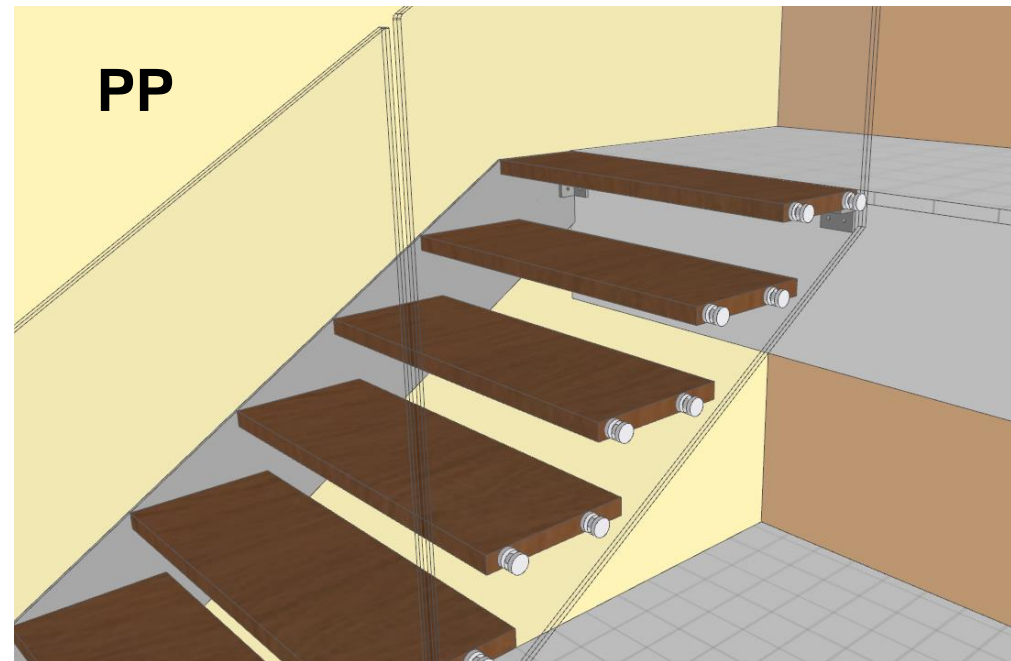

PP

Arrivo con gradino pari pavimento, arrivée au sol, arrival to the floor

Schemi partenze, plans de départs, departures schemes

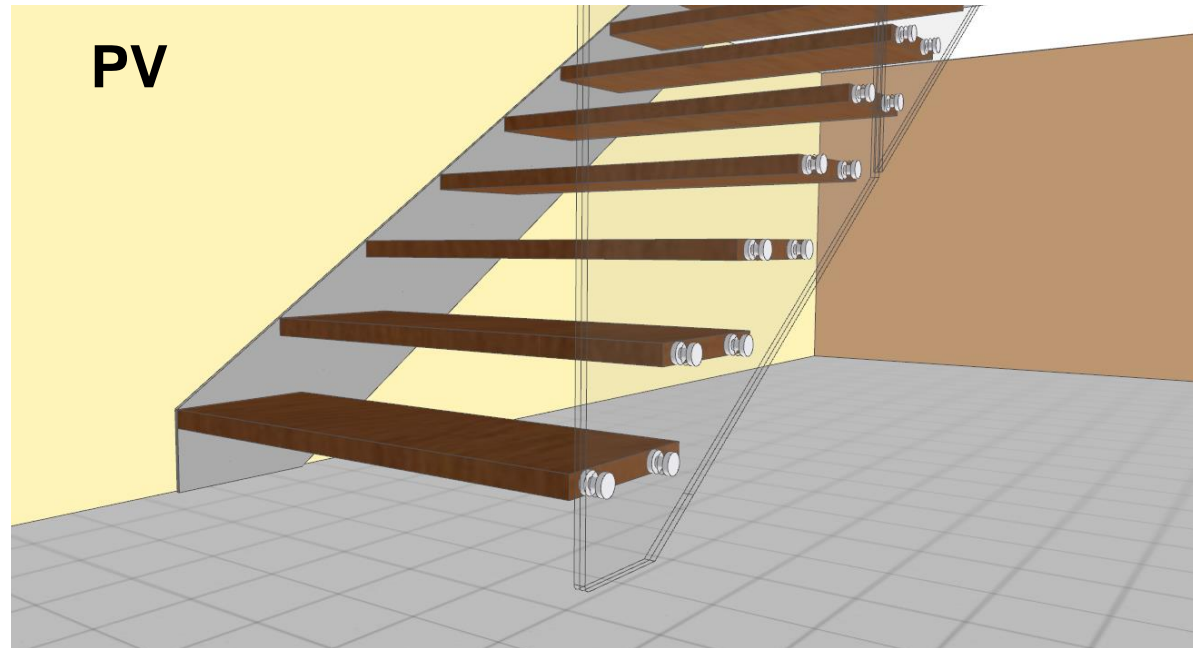

Partenza a pavimento, marche de départ au sol, starting floor

Balaustre al piano, garde-corps de trémie, balustrade

Model RX2

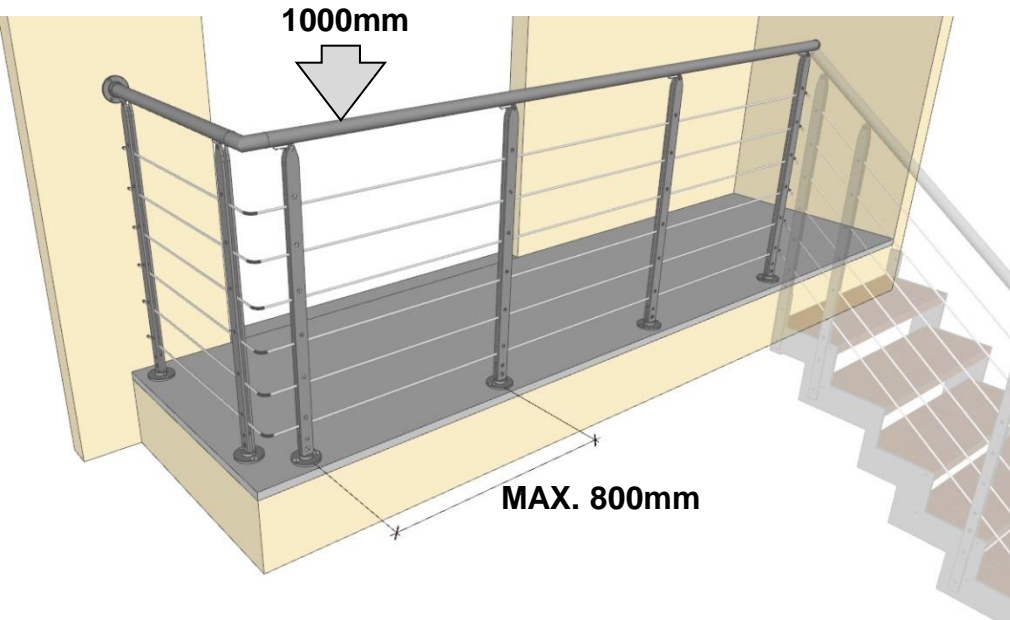

Balaustra con fissaggio a pavimento,

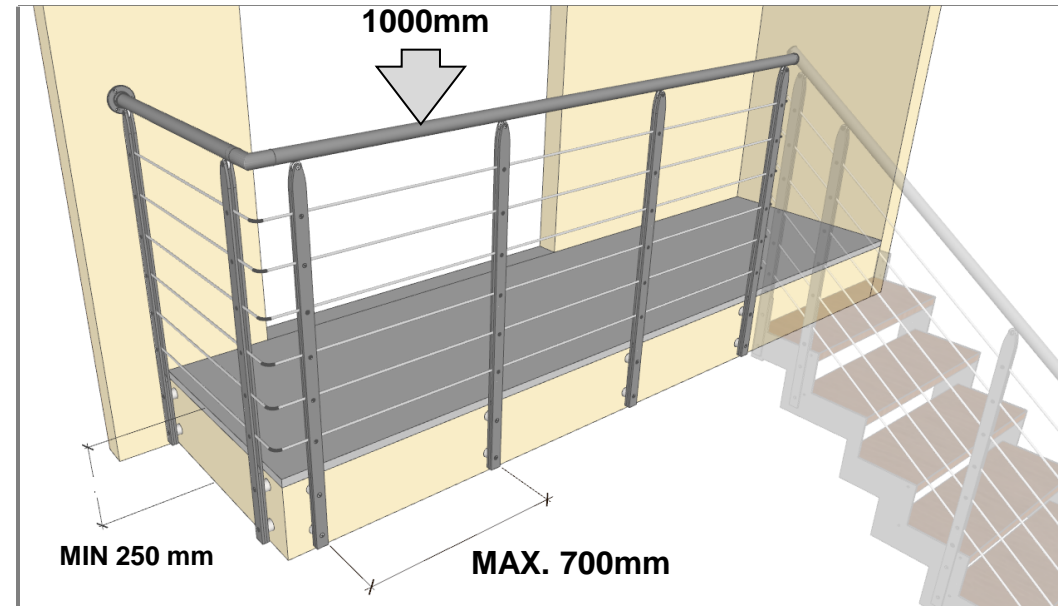

Balaustra con fissaggio a soletta,

Balaustre al piano, garde-corps de trémie, balustrade

Model XR

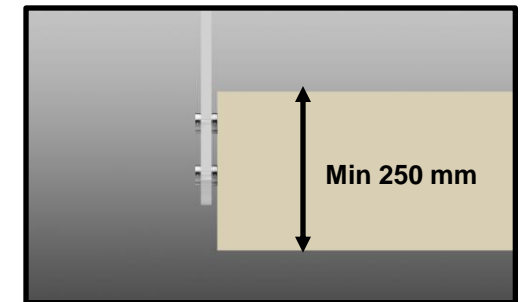
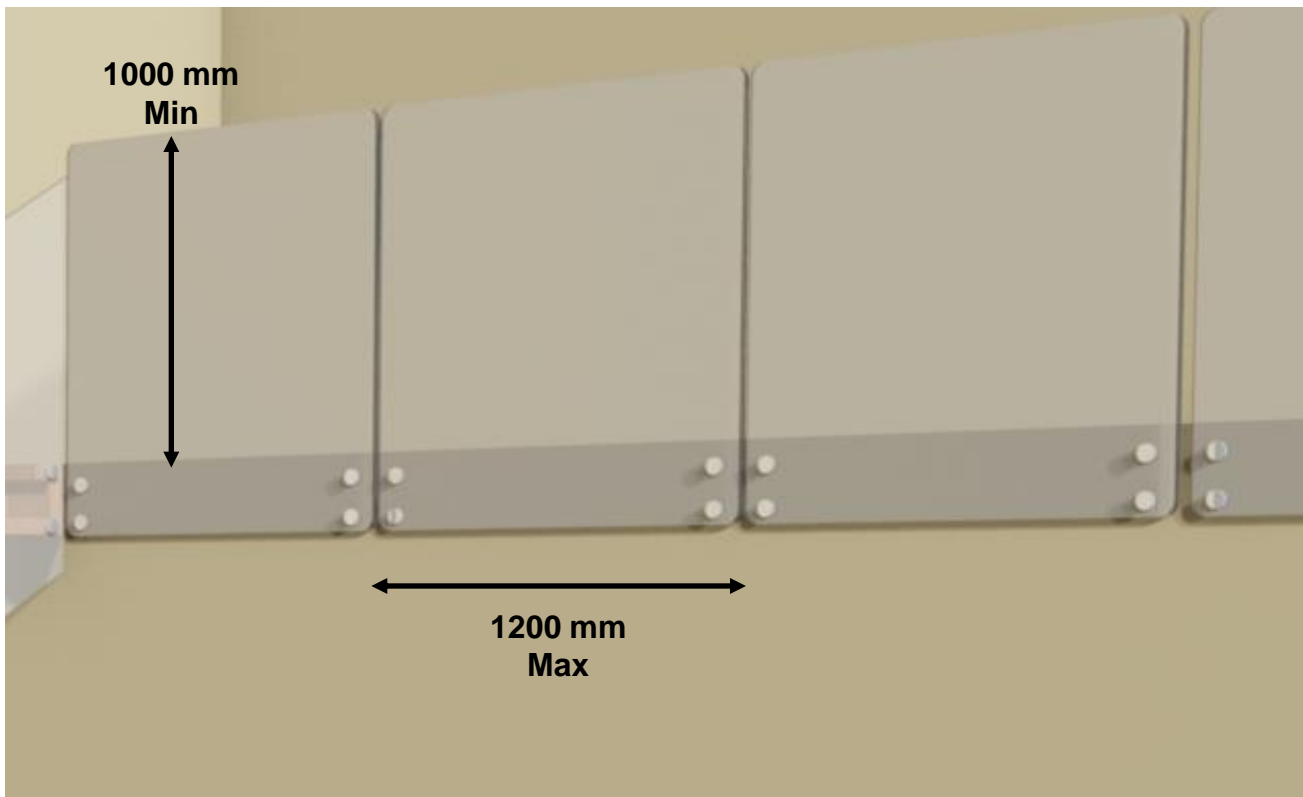

OPTIONAL

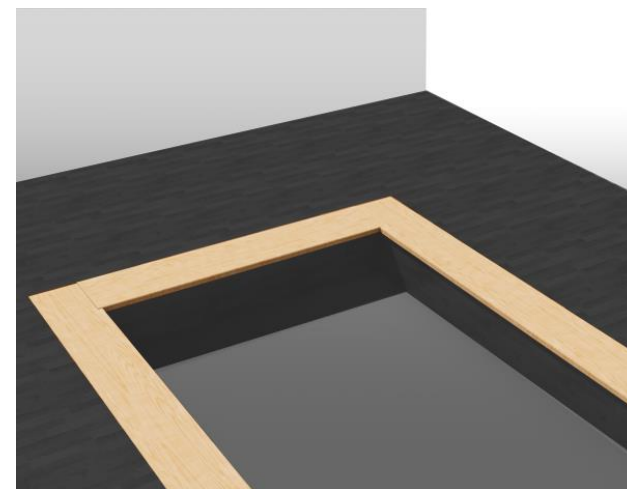

COLORS

Faggio, Beech, Hêtre, Buche, Haya



252
Noce medio
Light chestnut
Nussbaumholz
Noyer moyen
Nogal medio



253
Naturale
Natural
Naturbuchenholz
Couleur naturelle
Natural



258N
Rovere
Oak
Eichenholz
Couleur rouvre
Roble



287
Ciliegio
Cherry stain
Kirschholz
Couleur cerisier
Color cerezo



289
Doussié
Doussié
Doussié
Doussié
Doussié



311N
Sbiancato
Whitened wood
Bleichesholz
Blanchi
Madera blanqueada



312
Wenghè
Wenghè
Wenghè
Wenghè
Wenghè



400
Grigio
Grey
Grau
Gris
Gris



410
Cacao
Cacao
Kakao
Cacao
Cacao



420N
Sabbia
Sand
Sandfarben
Sable
Arena



430N
Tortora
Dove grey
Taubengrau
Gris tourterelle
Gris ceniciento



305S
Bianco
White
Weiß
Blanc
Blanco



390S
Nero
Black
Schwarz.
Noir
Negro



401DEC
Grigio
Grey
Grau
Gris
Gris



411DEC
Cacao
Cacao
Kakao
Cacao
Cacao



421DEC
Sabbia
Sand
Sandfarben
Sable
Arena



431DEC
Tortora
Dove grey
Taubengrau
Gris tourterelle
Gris ceniciento

COLORS

Rovere, Oak, Chêne, Eichen, Roble



252
Noce medio
Light chestnut
Nussbaumholz
Noyer moyen
Nogal medio



253
Naturale
Natural
Naturbuchenholz
Couleur naturelle
Natural



287
Ciliegio
Cherry stain
Kirschholz
Couleur cerisier
Color cerezo



289
Doussié
Doussié
Doussié
Doussié
Doussié



311
Sbiancato
Whitened wood
Bleichesholz
Blanchi
Madera blanqueada



312
Wenghè
Wenghè
Wenghè
Wenghè
Wenghè



400
Grigio
Grey
Grau
Gris
Gris



410
Cacao
Cacao
Kakao
Cacao
Cacao



420
Sabbia
Sand
Sandfarben
Sable
Arena



430
Tortora
Dove grey
Taubengrau
Gris tourterelle
Gris ceniciento



305S
Bianco
White
Weiß
Blanc
Blanco



390S
Nero
Black
Schwarz.
Noir
Negro



401DEC
Grigio
Grey
Grau
Gris
Gris



411DEC
Cacao
Cacao
Kakao
Cacao
Cacao



421DEC
Sabbia
Sand
Sandfarben
Sable
Arena



431DEC
Tortora
Dove grey
Taubengrau
Gris tourterelle
Gris ceniciento

COLORS

Trattamenti del legno - Wood treatments - Traitements du bois

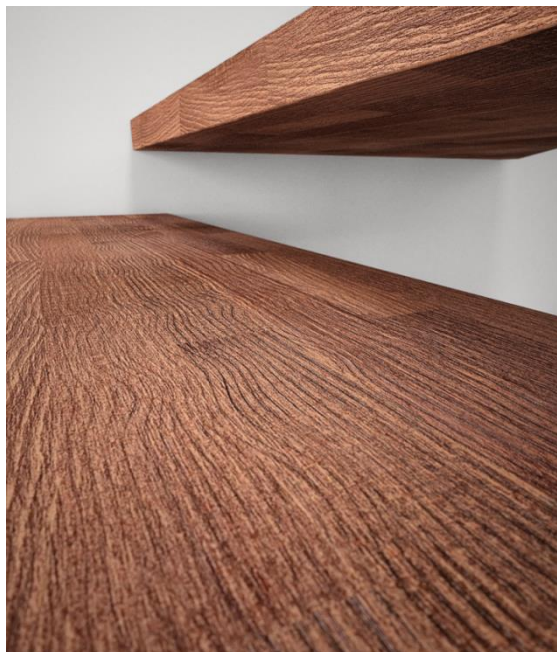

Trattamento spazzolato, brushed treatment, Traitement brossé

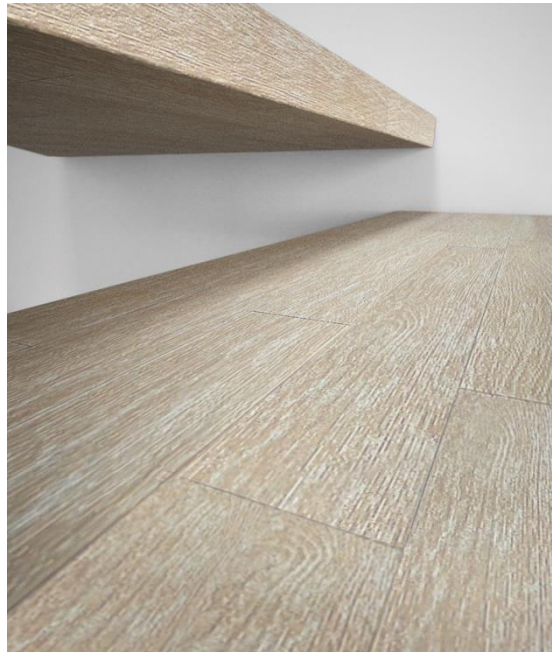

Trattamento decapato, Decapè treatment, Traitement decapé

Metal



90 RG
Bianco raggrinzato
Wrinkled White
Granité Blanc
Runzlig Weiss
Blanco arrugado

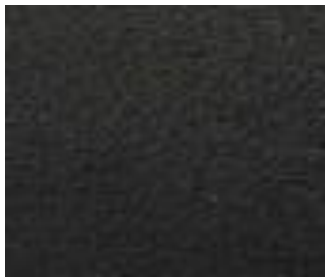

95 RG
Nero raggrinzato
Wrinkled Black
Noir granité
Schwarz runzlig
Negro arrugado

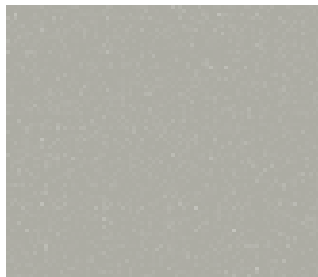

97 RG
Grigio raggrinzato
Wrinkled Grey
Gris granité
Grau runzlig
Gris arrugado



Inox

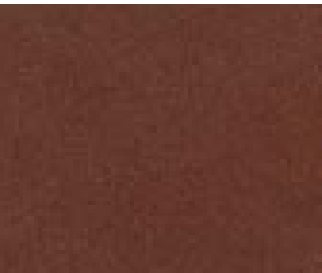

COR80
Effetto Corten
Corten effect
Effet corten
Corten – Effekt
Efecto corten

Vetro, verre, glass



Natuale, Extra chiaro
Naturel, Extra clair
Natural, Extra light