

## ECON

### DIAMETRI E PIANEROTTOLI, DIAMETERS AND LANDINGS, DIAMÈTRES ET PALIERS

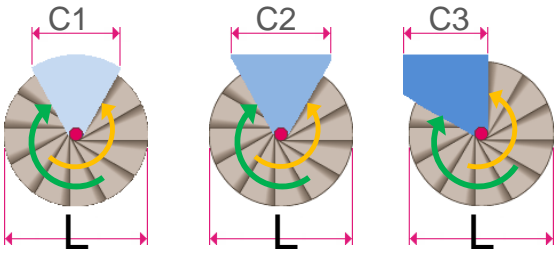

L	C1	C2	C3
1000	532	609	520
1100	578	660	570
1200	624	711	620
1400	716	813	720
1600	808	915	820

Diametri disponibili, senso di salita, forme e possibili pianerottoli d'arrivo con dimensione d'uscita per scale a pianta circolare e a pianta quadra.

Available diameters, staircase rotation, shapes and possible arrival landings with exit dimension for round and well staircases.

Diamètres disponibles, sens de rotation, formes et possibles paliers d'arrivée avec dimension de sortie pour escaliers ronds ou carrés.

### FORO, WELL, TRÉMIE

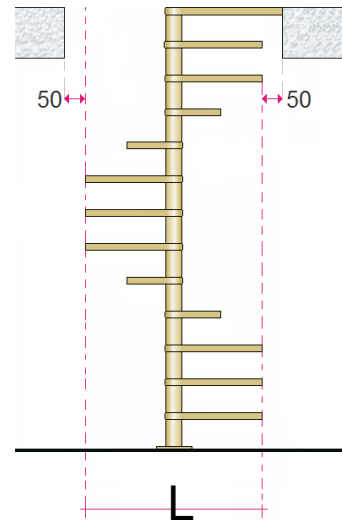

### APERTURA GRADINI, TREADS OPENING, OUVERTURE DES MARCHES

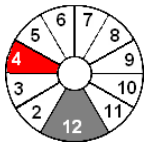

L 1000 ÷ 1200  
Y = 30°

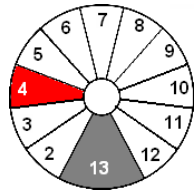

L 1400 - 1600  
Y = 27°

### FISSAGGIO ARRIVO SBARCO, FIXING OF THE ARRIVAL LANDING, FIXATION DU PALIER D'ARRIVÉE

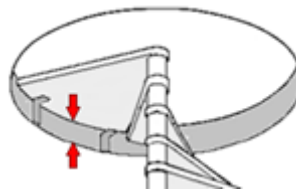

MIN 210

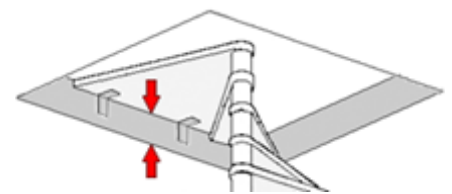

MIN 210

### ALTEZZE E NUMERO GRADINI, FLOOR HEIGHTS AND TREADS NUMBER, HAUTEURS ET NOMBRE DES MARCHES - G11 ÷ G...

Ø 1000 ÷ 1600

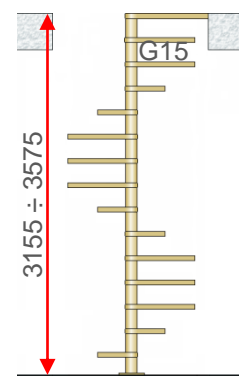
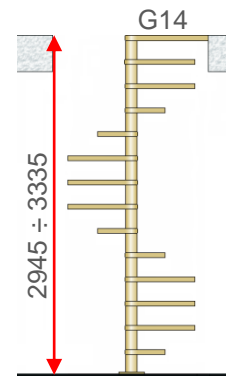
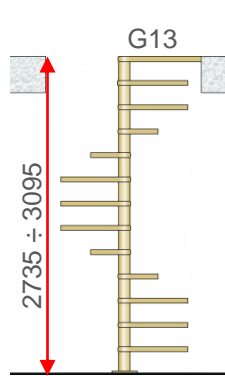
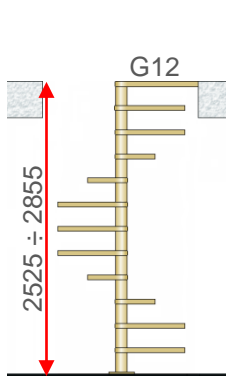
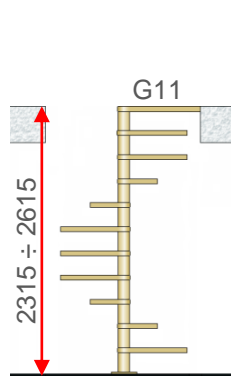

MIN 210 ÷ MAX 240

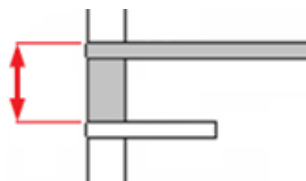

## ECON

CARATTERISTICHE, FEATURES, CARACTÉRISTIQUES

CORRIMANO PVC GRIGIO  
PVC HANDRAIL GREY  
MAIN COURANTE PVC GRIS

RINGHIERA A COLONNE Ø 22mm  
E CAVI IN ACCIAIO Ø 4mm  
BANISTER WITH SPINDLES Ø 22mm  
AND STEEL WIRES Ø 4mm  
GARDE-CORPS AVEC  
COLONNETTES Ø 22mm  
CABLES ET ACIER Ø 4mm

METAL

PALO METAL  
METAL CENTRAL POLE  
POTEAU OU MÉTAL

PORTATA 200 Kg/m<sup>2</sup>  
LOAD 200 Kg/m<sup>2</sup>  
PORTÉE 200 Kg/m<sup>2</sup>

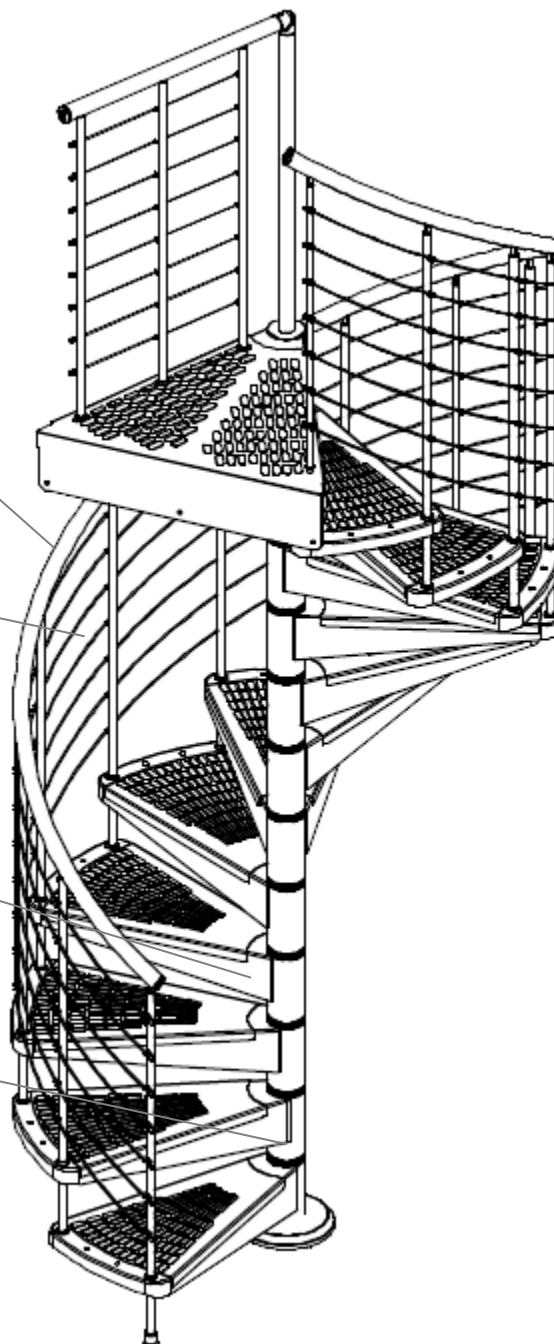

Ø 1100 ÷ 1600



Ø 1000 - 1800 - 2000

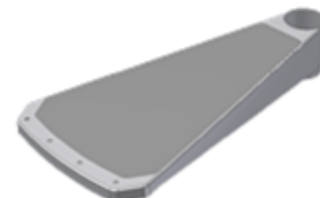

SENSO DI SALITA: ORARIO E ANTIORARIO  
USO INTERNO  
STAIRCASE ROTATION: CLOCKWISE AND ANTICLOCKWISE  
INTERNAL USE  
SENS DE MONTÉE: HORAIRE OU ANTI-HORAIRE  
USAGE INTÉRIEUR

## ECON

BALAUSTRE PROTEZIONE FORO, FLOOR PROTECTION BALUSTRADE, GARDE-CORPS ÉTAGE POUR LA TRÊMIE

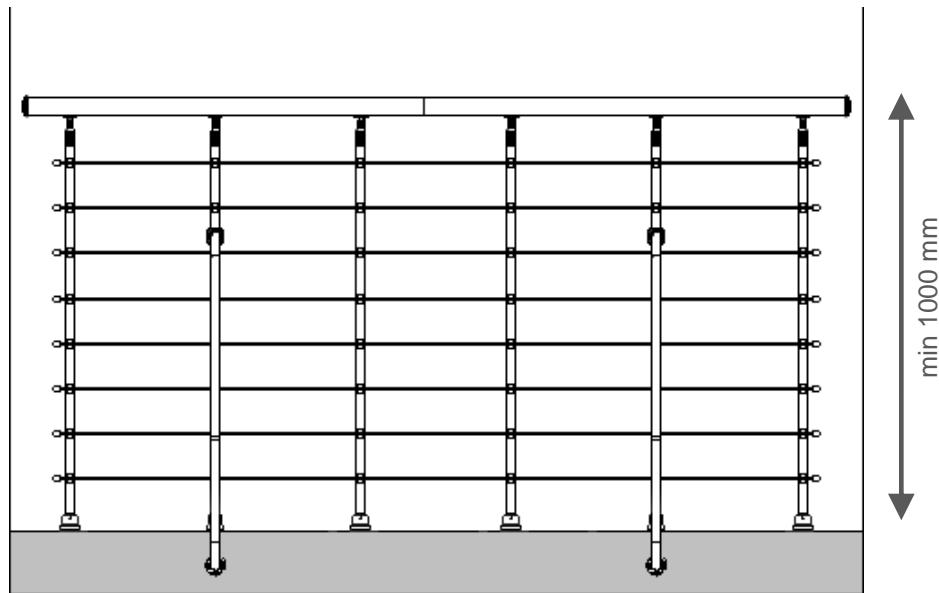

max 1000 mm

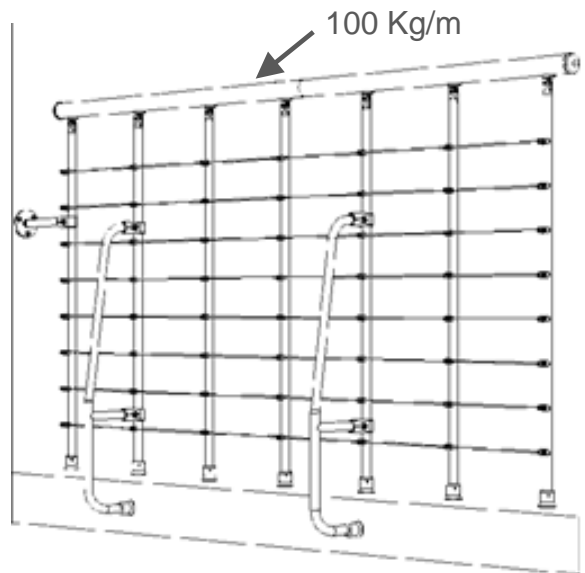

CORRIMANO OVC – PVC handrail - Main courante PVC

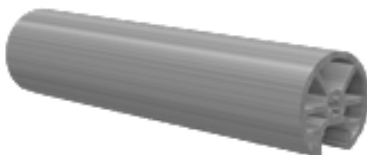

## ECON

### COLORS METAL ECON FX-Z



Zinco

### COLORS METAL ECON FX-VZ

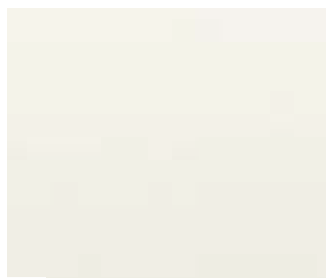

RAL 9001  
Bianco  
White  
Blanc  
Weiss  
Blanco



95 RG  
Nero raggrinzato  
Wrinkled Black  
Noir granité  
Schwarz runzlig  
Negro arrugado



97 RG  
Grigio raggrinzato  
Wrinkled Grey  
Gris granité  
Grau runzlig  
Gris arrugado

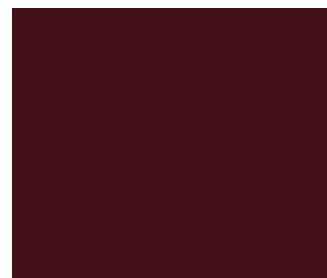

RAL 3005  
Bordeaux



RAL 5002  
Blu  
Blue  
Bleu  
Blau  
Azul



RAL 6026  
Verde  
Green  
Vert  
Grün  
Verde



RAL 3000  
Rosso  
Red  
Rouge  
Rot  
Rojo



RAL 1021  
Giallo  
Yellow  
Jaune  
Gelb  
Amarillo